

# A Few Good Knots

&  
Bends and Hitches

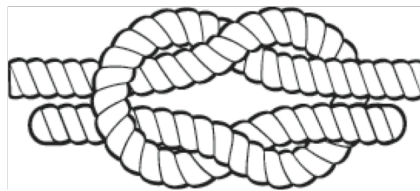

2.2

by  
Forbes Pettigrew



Guayacán

A small selection of  
honest Knots,  
Bends and Hitches,  
such that our readers  
may find of use in their  
travels and wanderings.

This booklet is dedicated to the person who, when attempting to tie a Reef Knot ends up with a Granny Knot, and is curious as to why.

***Knot:*** An intertwining or complication of the parts of one or more ropes, cords, or strips of anything flexible enough, made for the purpose of fastening them together or to another object, or to prevent slipping, and secured by being drawn tight.

***Bend:*** A knot, used to unite one rope to another, or to something else.

***Hitch:*** Applied to a noose or knot of various kinds, by which a rope is caught round or temporarily made fast to some object.

*Oxford English Dictionary - Second Edition 1989*

Forbes Pettigrew 2014

First published in 2013



This work is licensed under the Creative Commons License.  
[http://creativecommons.org/licenses/by-nc-nd/3.0/deed.en\\_US](http://creativecommons.org/licenses/by-nc-nd/3.0/deed.en_US).

**You are free:** to Share — to copy, distribute and transmit the work under the following conditions:



**Attribution** — You must attribute the work to the author. It must not be stated nor implied that this work is other than the author's work.



**Noncommercial** — You may not use this work for commercial purposes, nor make directly or indirectly any monetary gain.



**No Derivative Works** — You may not alter, divide, extract text or images, nor transform or build upon this work in any way.

The author may be contacted at [mapologo@gmail.com](mailto:mapologo@gmail.com)

Author's note: There are several references in this Knot Booklet to ABoK. ABoK is the acronym of Ashley's Book of Knots. This opus magnum of Clifford W. Ashley was first published in 1944 and subsequently reprinted with amendments in 1993.

With thousands of drawings representing hundreds of knots, this tome has become the premier reference work of knotting.

Each drawing and hence each knot is identified by a number.

With many knots having more than a single name in any one language, an Ashley's Book of Knots *reference number* has become the equivalent of the *Binomial* or *Latin* name in Zoology and Botany.

It should be pointed out however that new knots and those that for whatever reason did not appear in Ashley's Book of Knots lack an ABoK number.

<b>Contents</b>	<b>Page</b>
Introduction	6
Basics	7
Hitches	11
Fixed Loops	18
The Noose	26
Bends	27
Binders	31
Stopper Knots	35
Friction Knots	37
Slings and Recovery Straps	40
Lashings	41
Whipping	43
Index	44

## **Introduction**

### **Characteristics of a good working knot**

There are five boxes that a good working knot should tick, the first four are: it should be secure, quickly made, easily checked and yet readily undone. The fifth box is no less important: it should be matched to its use.

### **From Strength to Weakness**

The strength of a rope as stated by the manufacturer is for new unused rope. With use, as the rope is subjected to strain, dirt, kinks, scuffs, sunlight, mildew, knocks, incorrect storage and a myriad of other stresses its strength slowly decreases over time.

Additionally, every knot weakens the rope it is made in. Precise figures are hard to come by but a reduction in rope strength from 20% up to 50% for some knots, particularly those which stress the rope with sharp angled turns, are generally recognized to be correct.

Keep an eye on the condition of the rope, the knots you are using and the use you are putting the rope to. Remember that ropes need to be replaced and or downgraded (to other uses) periodically, or sooner if damaged.

### **Material**

Knots have been made in many materials, from hair and leather to catgut. Ropes however, were generally made in natural fibres such as manila, hemp, jute, coir (from coconuts) and sisal to name but a few.

Modern rope is made from artificial fibres such as nylon (polyamide), polypropylene, polyethylene and polyester. It is available in various mixes, weaves, braids and cores.

For most uses modern ropes have supplanted natural fibre ropes due to their increased strength, reduced weight and longer lengths. Each of the artificial fibres gives the rope different characteristics. Some float, others are sensitive to ultraviolet light, still others stretch and some do not.

For general use such as camping or tying things on to a roof rack, most ropes will do. For ropes for more specialized pursuits, one should inquire from those with experience in that particular area.

### **Knot Tyers**

To become proficient in knot tying it is not enough to learn a knot by rote, whether mechanical or mnemonic. One must be aware of how a knot is made; this is what allows one to verify if a knot is tied correctly or not.

## Basics

### Parts of a Rope

It is by knowing the parts of a rope and how they interact that knots are distinguished, described and made. Even when good drawings, photographs or videos exist, written instructions compliment them, helping to identify each knot and clarify how to tie them correctly; they are also useful as a mnemonic device.

The Working End of a rope is, happily enough, the end of the rope one is working with to make a knot. If one were to tie a clothesline for example, each end of the rope would become in turn the Working End as each end was in its turn, tied.

The Standing Part of the rope is the main part of the rope; it plays a passive role during the making of a simple knot.

A Bight is an open loop, a Loop has its ends crossed. A twisted Loop has an Elbow for each twist made. The Standing End, the far part of the rope, can be loose or fixed to something.

A knot made in the middle of the rope without the use of the Working End is said to be made in the Bight. Not all knots can be made in the Bight.

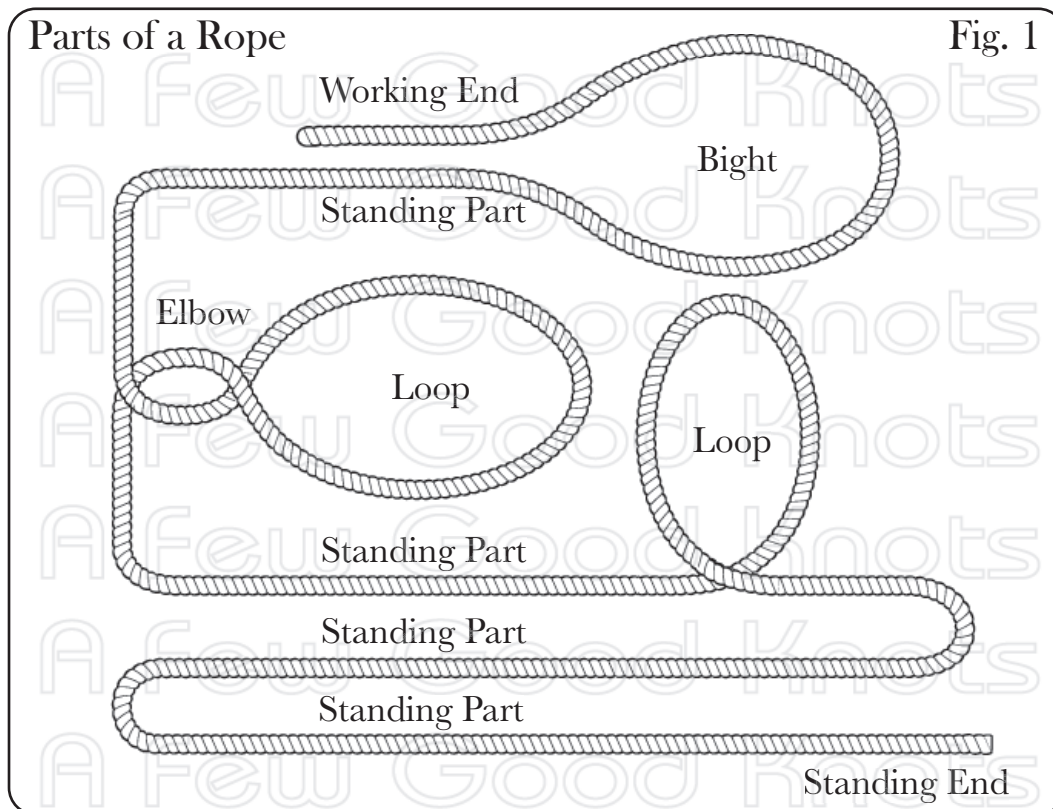

## The Overhand and Underhand Loop and Knot.

The Overhand and Underhand Loop, the Overhand Knot, along with the Half Knot and the Half Hitch are the building blocks of knot making.

*Note: In knot making the Overhand and Underhand Knot are often, but not always interchangeable. Knot instructions tend to refer to the Overhand Knot unless otherwise required.*

This is not the case of the Overhand and Underhand Loop, the substitution of one for the other requiring either different knot making instructions or in many cases simply resulting in another knot or no knot at all.

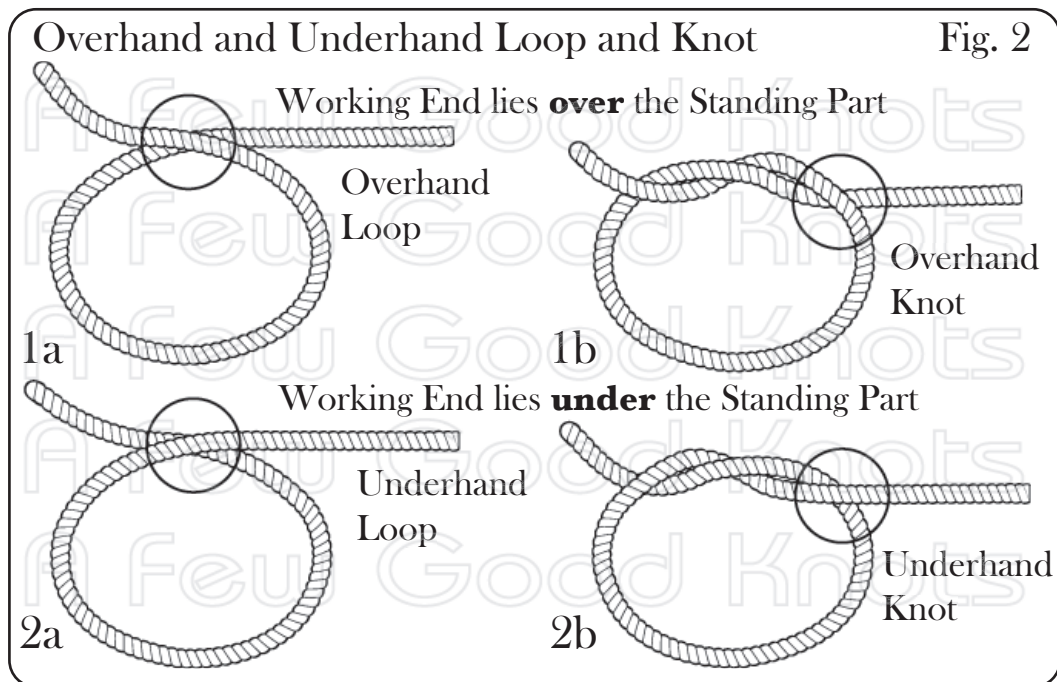

A good example of this is the Bowline (pronounced bo-lyn) Knot, usually referred to simply as the Bowline. This classic knot (see Fig. 18 and 19) is made with the following instructions.

*Overhand Loop:*

*Form an Overhand Loop in the Standing Part of the rope, pass the Working End **up** through the loop, **under** the Standing Part, around and **down** through the loop.*

*Underhand Loop:*

*Form an Underhand loop in the standing part of the rope, pass the Working End **down** through the loop, **over** the Standing Part, around and **up** through the loop.*



**The Overhand Knot (ABoK # 46)**

**The Half Knot (ABoK # 47)**

**The Half Hitch (ABoK # 48)**

The difference between an Overhand Knot, a Half Knot and a Half Hitch is not how they are tied but rather the use they are put to.

Likewise the relevance as to whether or not they are tied Overhand or Underhand depends on the application of the knot.

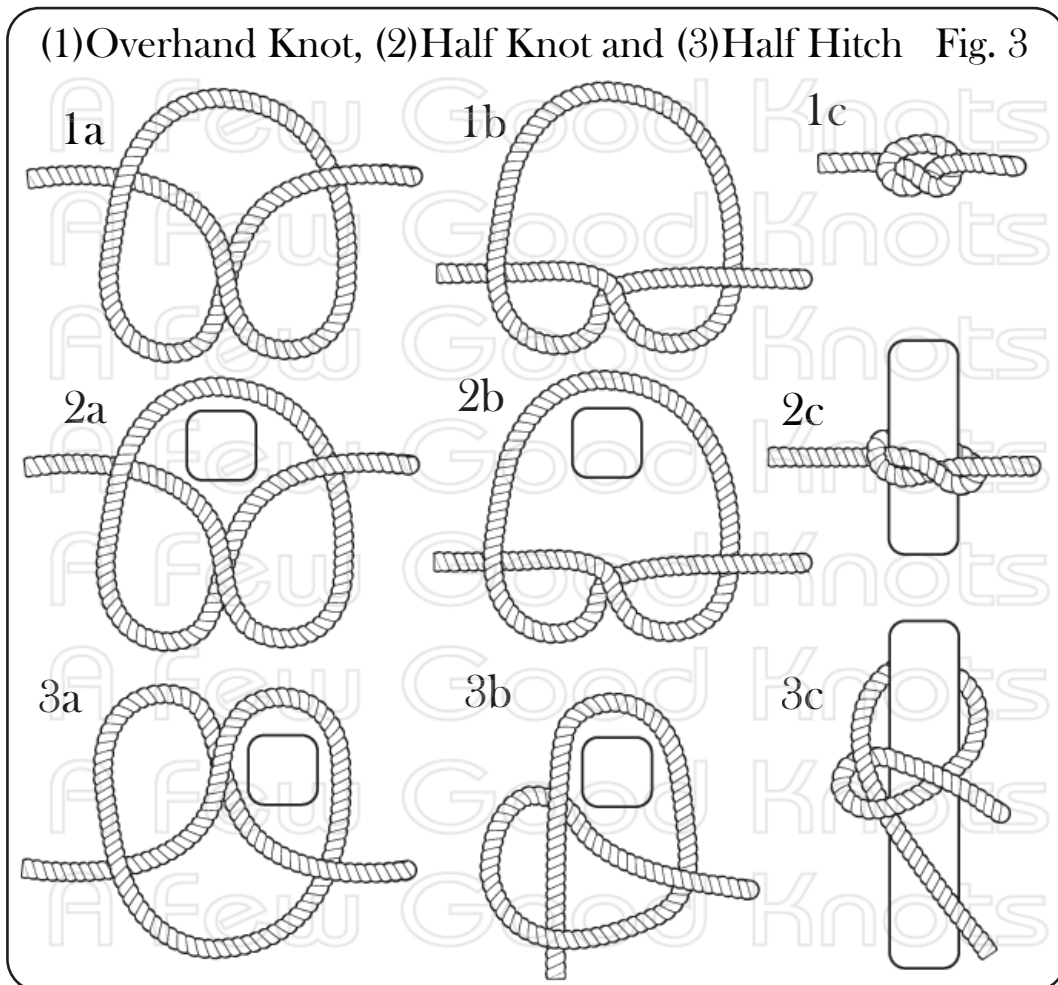

## The Single Hitch and the Half Hitch (ABoK # 49 & 50 and 3114)

A Single Hitch consists of the rope passed around an object and secured under its turn (see Fig. 4 # 1 & 1a).

The Half Hitch consists of a Single Hitch over the ropes own Standing Part. (see Fig. 4 # 2 & 2a).

The knot described as: *a Round Turn and two Half Hitches* (see Fig. 8) could also be described as *a Round Turn and two Single Hitches on the Standing Part!*

The term Half Hitch is, in a few specific cases, due to long-standing convention, used to describe a Single Hitch.

The Timber Hitch + Half Hitch being a case in point (see Fig. 11).

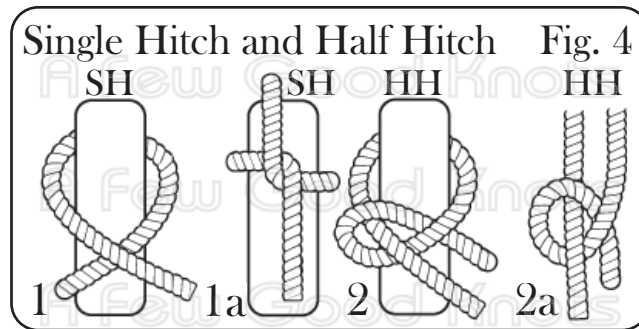

## Two Half Hitches – Clove & Paired

If two Half Hitches are crossed (Fig. 5 # 1), the Working End crosses over the Standing Part to form the second hitch, the result is a Clove Hitch; if the two Half Hitches are not crossed (Fig. 5 # 2), the result is a Paired Hitch.

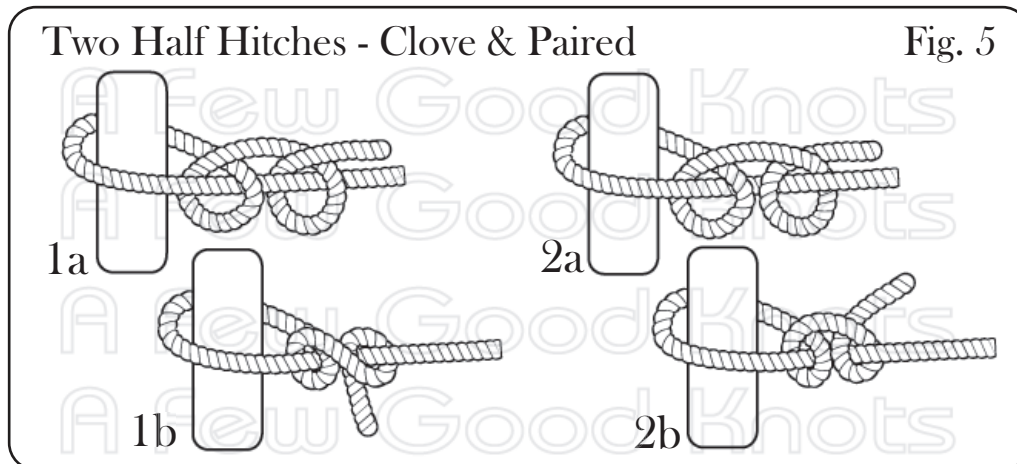

## Hitches

### The Clove Hitch (ABoK # 1178)

The Clove Hitch is a simple yet useful hitch. It is used to secure more complex hitches, in lashings, to make rope fencing, to temporarily moor small boats, in climbing, where it is tied around a ring or a karabiner and as a general utility knot.

The Clove Hitch can be tied in the Bight (see Fig. 6) or with the Working End (see Fig. 6a).

To make the Clove Hitch on the Bight make two Overhand Loops, placing the second one under the first one and drop both over the bollard or post. If instead you make two Underhand Loops then either reverse the order, placing the first one under the second one or drop them one after the other over the post or bollard. Do not mix the Loops.

A third Single Hitch can be added for extra security once the knot is made.

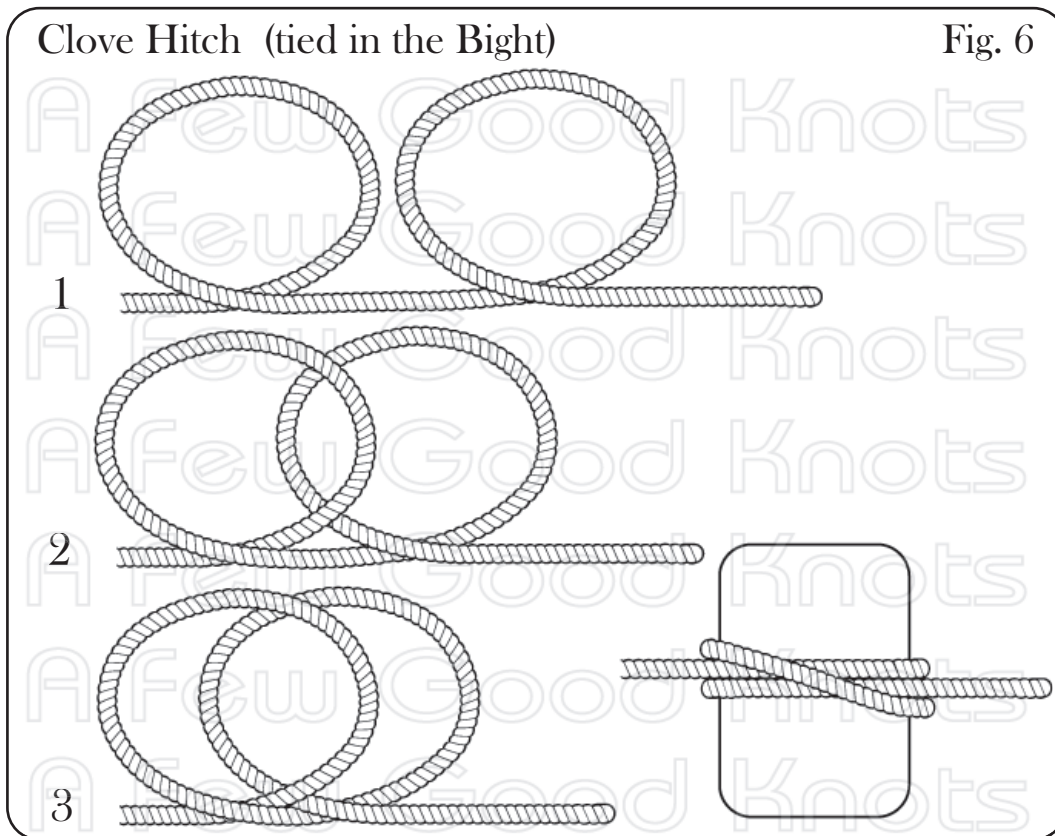

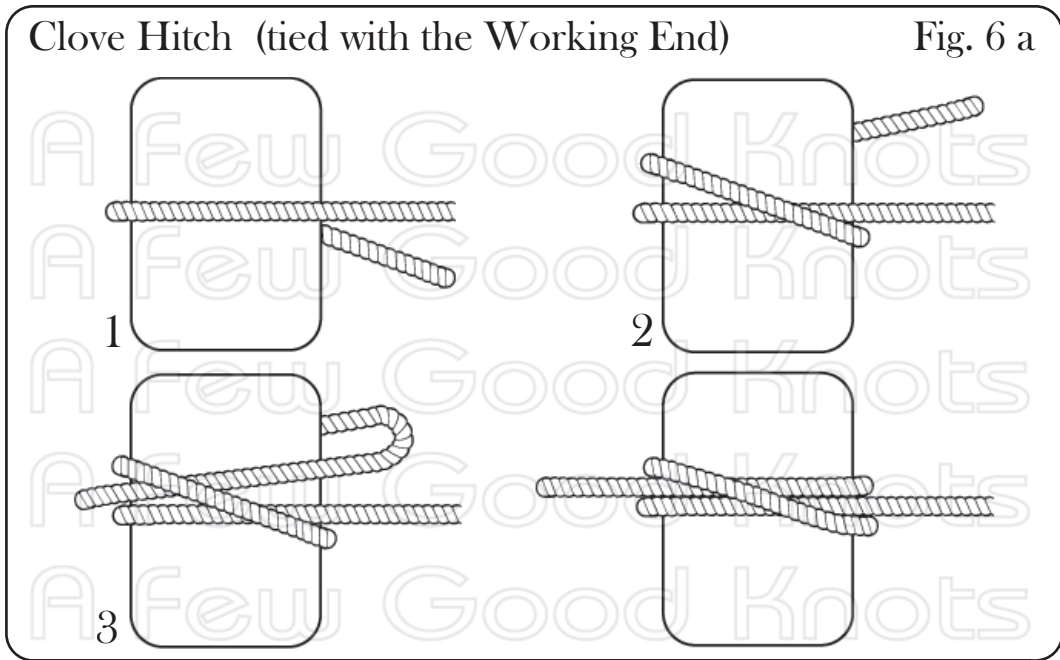

**Turns** are part and parcel of many knots, particularly Hitches.

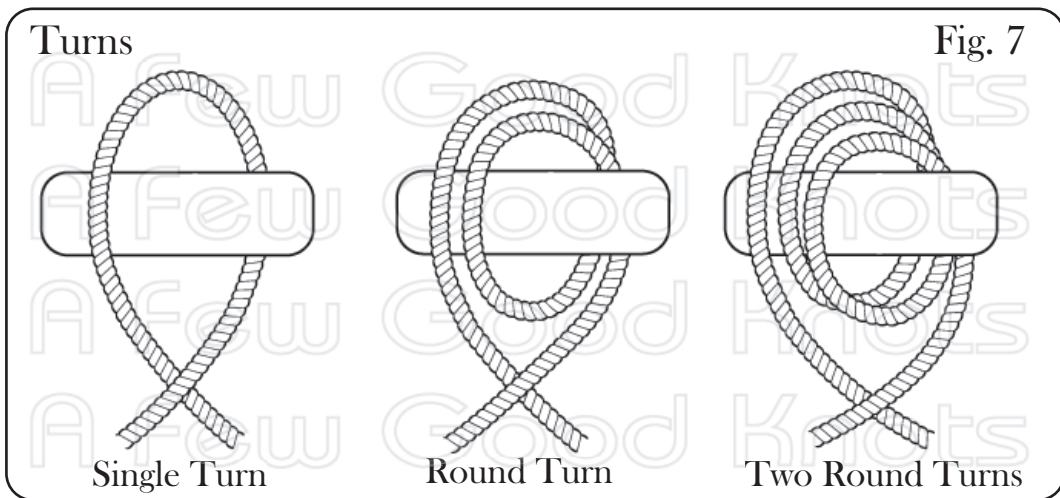

### The Round Turn and Two Half Hitches (ABoK # 1720)

This classic knot, which consists of a Round Turn (and a Clove Hitch on the Standing Part) is the quintessential hitch; its ability to be untied under tension allows it to fulfil many of the duties required of a hitch.

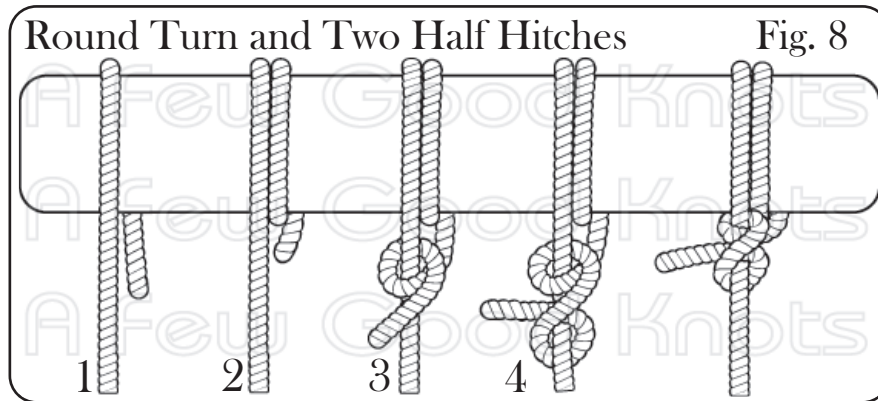

### The Anchor Bend (Fisherman's Bend) (ABoK # 1841)

This curiously named Hitch (one bends a rope to an anchor), differs from the Round Turn and Two Half Hitches only in that the first hitch goes through the Round Turn. It is more secure, but cannot be untied under tension; an aspect which limits its general use but which makes it useful on anchors and other objects where security is more important than ease of untying.

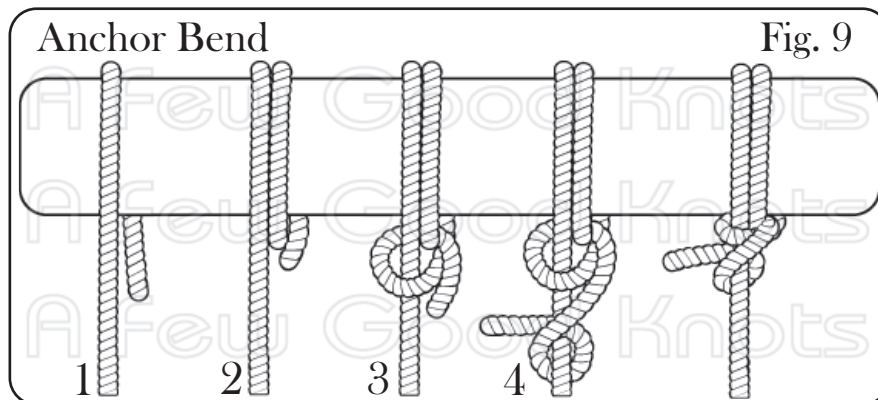

**The Buntline Hitch** (ABoK # 1847)

This knot is also secured with a Clove Hitch, but in this case with the second Half Hitch above the first. This traps the Working End making this Hitch ideal for awnings and tarpaulins or any situation where the rope tends to be flogged or thrashed about.

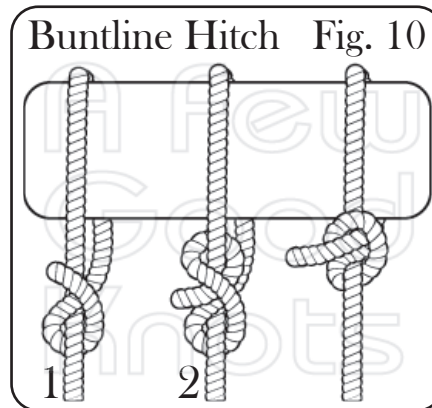

**The Timber Hitch and Half Hitch** (ABoK # 1733)

As its name implies it is used to secure both sawn timber and logs. Despite appearances it grips surprisingly well on rough uneven surfaces. The added "Half Hitch" (more may be added) maintains the lay of the knot, increasing its security and also allowing straight-line pulls.

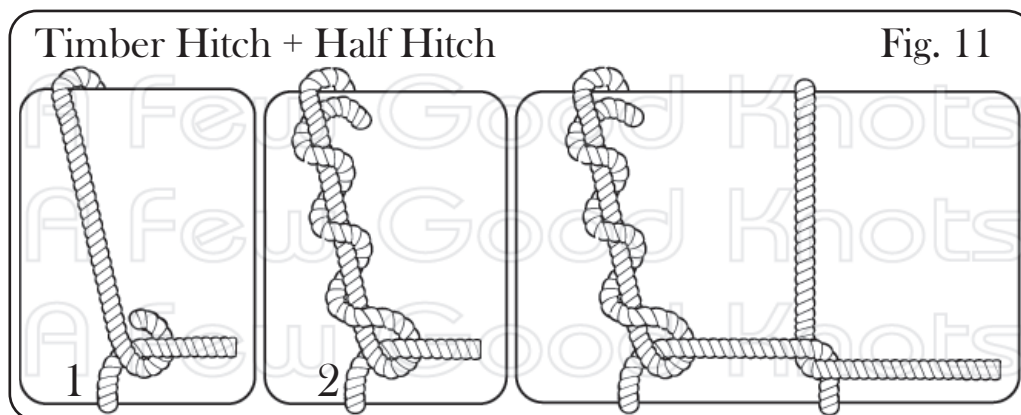

**The Midshipman's Hitch** (ABoK # 1799)

and **The Rolling Hitch** (*Tautline Hitch*) (ABoK # 1800)

**The Midshipman's Hitch** and **The Rolling Hitch** are both slide and grip knots. They can be tied around a tensioned rope (the pull should be towards the side with the Round Turn), where they can ease the load – an extra turn may be added to increase grip – or they can be tied to themselves creating a Loop.

They differ only in that in the Midshipman's Hitch the second turn of the rope lies over the shoulder of the first, an arrangement that provides for increased grip. The Rolling Hitch tends to be favoured where the need is for a Hitch that can be repositioned more readily, such as the placing of fenders on a boat, while the Midshipman's Hitch tends to be used on guy lines. However, in practice, both Hitches are readily interchangeable.

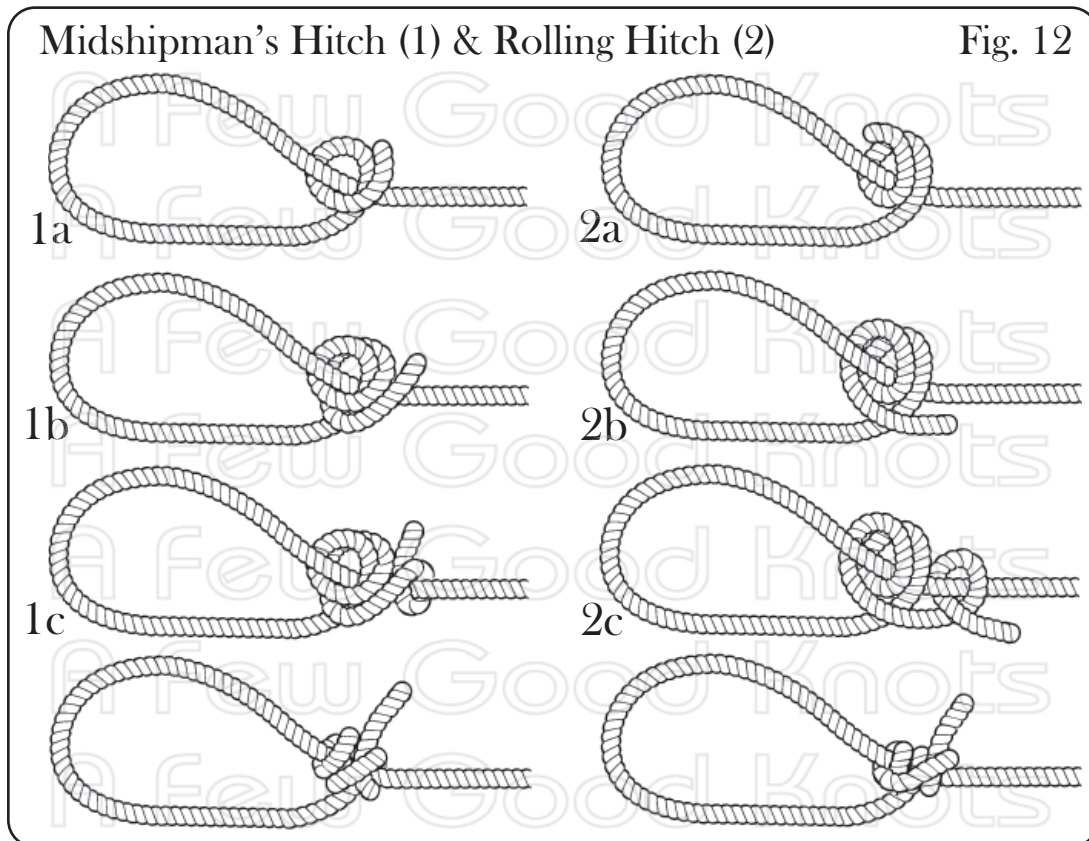

## The Waggoner's Hitch (*Trucker's Hitch*) (ABoK # 2126)

**The Waggoner's Hitch** in its many variations has been used to tie down loads from time immemorial. Though the knot may vary, the mechanics of it, that is, arranging the rope to achieve a mechanical advantage of 3 remain the same. The Knot consists in passing a bight through a hook or ring on the side of the vehicle and another through a loop in the standing part, as shown in (Fig. 13 and 14). Once the desired tension is achieved, the knot is secured with two or three Half Hitches around the first bight.

There are however many ways of making the loop in the standing part, apart from that of the traditional Waggoner's Hitch, such as the Directional Figure Eight (Fig. 29), the Alpine Butterfly (Fig. 30) or the Simple Noose (Fig 31), to name just a few.

Due to the large amount of friction, the mechanical advantage of 3 is just theoretical. The actual advantage varies, but even in the best of cases it is less than 2. Despite this the knot works well, because paradoxically, while the friction reduces the mechanical advantage on the one hand, it also allows the knot to be secured without loss of tension on the other.

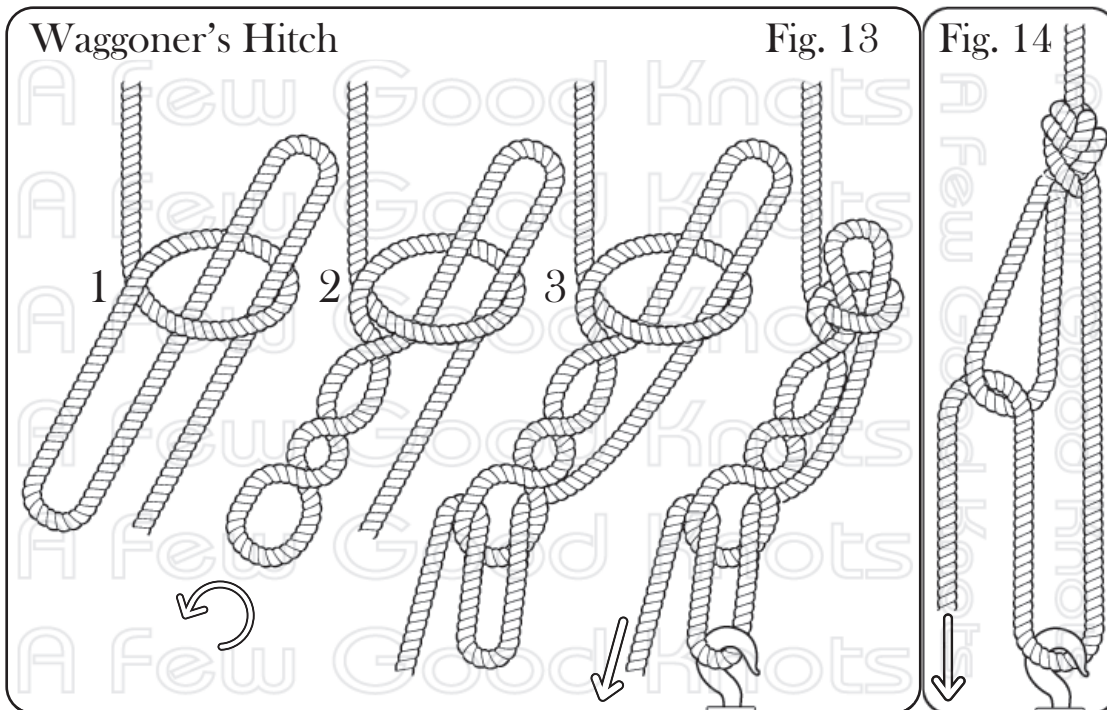



## Quick Release Hitches and Slipped Hitches

Quick Release Hitches are designed to collapse when the tail is pulled. In this they differ from Slipped Hitches, which are slipped versions of normal hitches, in which a bight from the tail rather than the whole tail is tucked through. They therefore tend to loosen, rather than fall apart.

**The Highwayman's Hitch** is perhaps the best known of the Quick Release Hitches. Note how the bight from the Standing Part is pulled through first (Fig. 15 # 1), while the second bight (Fig. 15 # 3), is made from the Tail.

In **The Tumble Hitch**, which is a more stable variation, both bights are made from the Tail (Fig. 16 # 1 & # 3). Notice that the second one passes behind the Standing Part before being tucked in at the front.

**Note:** Quick Release Hitches by their very nature are not secure.

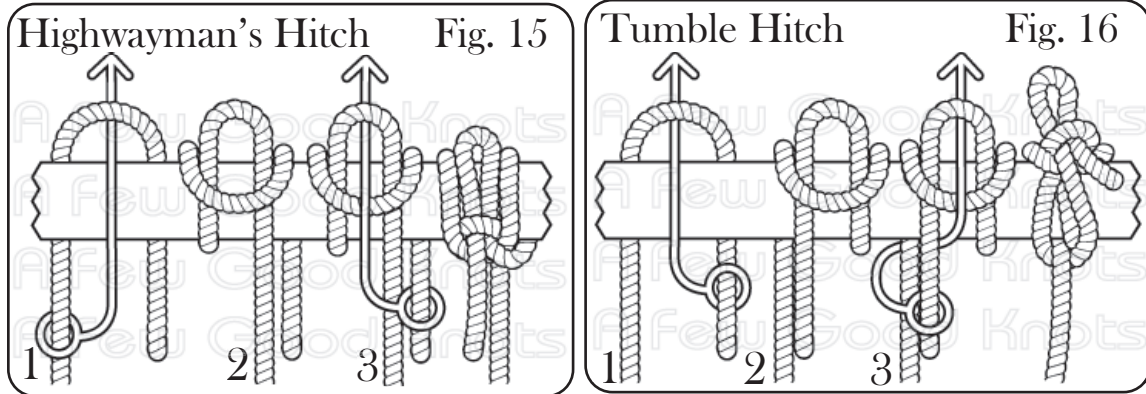

**Slipped Hitches** can be made from just about any Hitch (see Fig. 17); they tend to be used in circumstances in which the hitch is expected to be hard to untie or if speed is important. Example situations include difficulty in reaching the hitch, wet rope, or having to wear gloves or mittens.

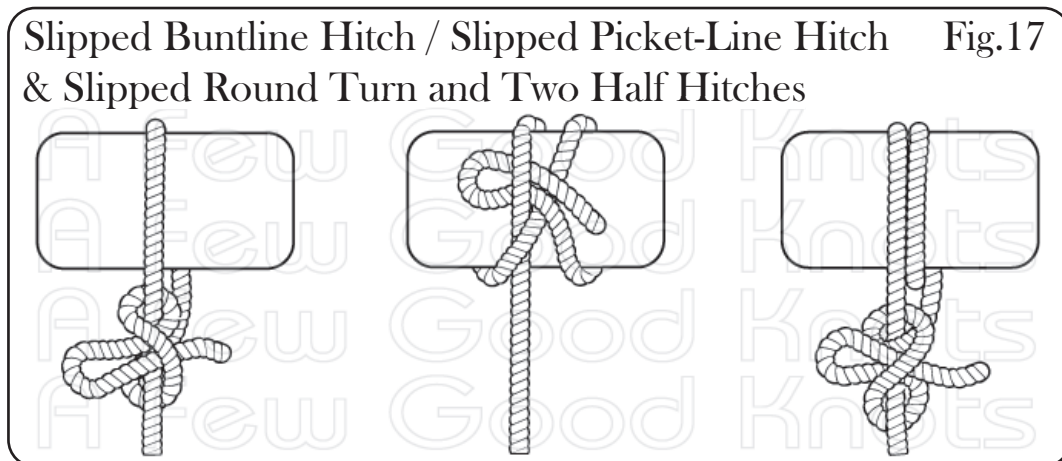

## Fixed Loops

### The Bowline

This knot is the best known and most useful of the Fixed Loops. It is easy to tie, in its variations – very secure, easily checked and easy to untie.

It can be tied with either an Overhand or an Underhand Loop (see Fig. 2 + tying instructions on page 8), and Right-Hand or Left-Hand. The terms come from the direction the Working End takes around the Standing Part – right to left or left to right. The most common form is Right-Hand with an Overhand Loop (ABoK # 1010) (see Fig. 18 # 1), the Left-Hand (ABoK # 1034½) (see Fig. 19) places the Tail on the outside of the Loop.

**Note:** In Fig. 18 # 2b and 19 # 2b, reverse of bowline shown for comparison.

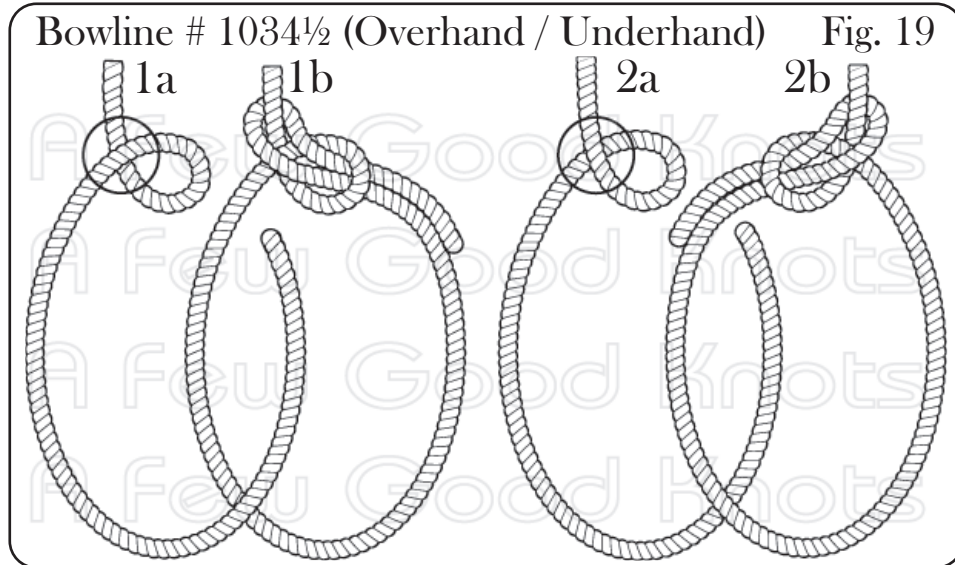
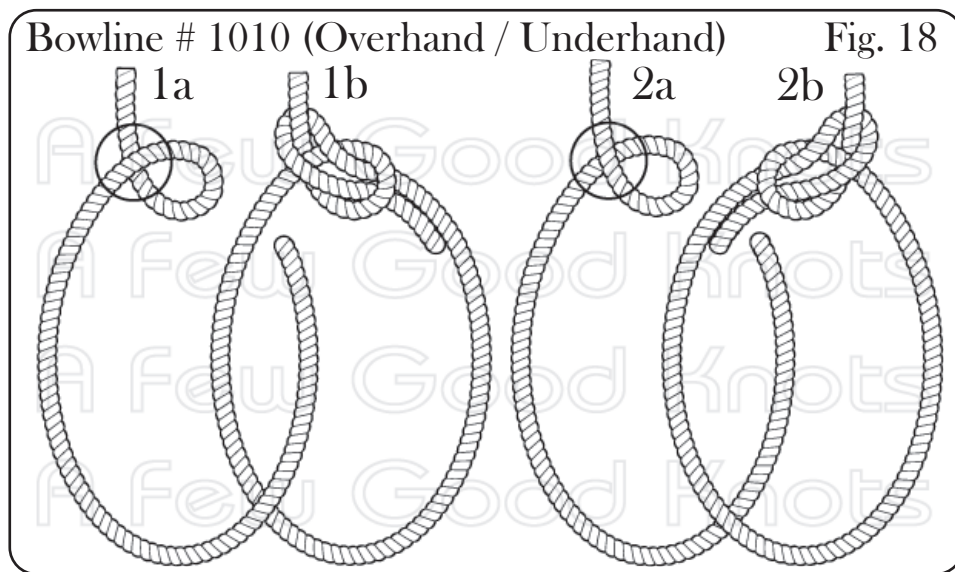

**The EBDB Bowline**, End Bound Double Bowline, is a variation of the Classic Double Bowline (ABoK # 1013), which is itself a step up in security. It is therefore not only more secure but also has the virtue of being easy to tie.

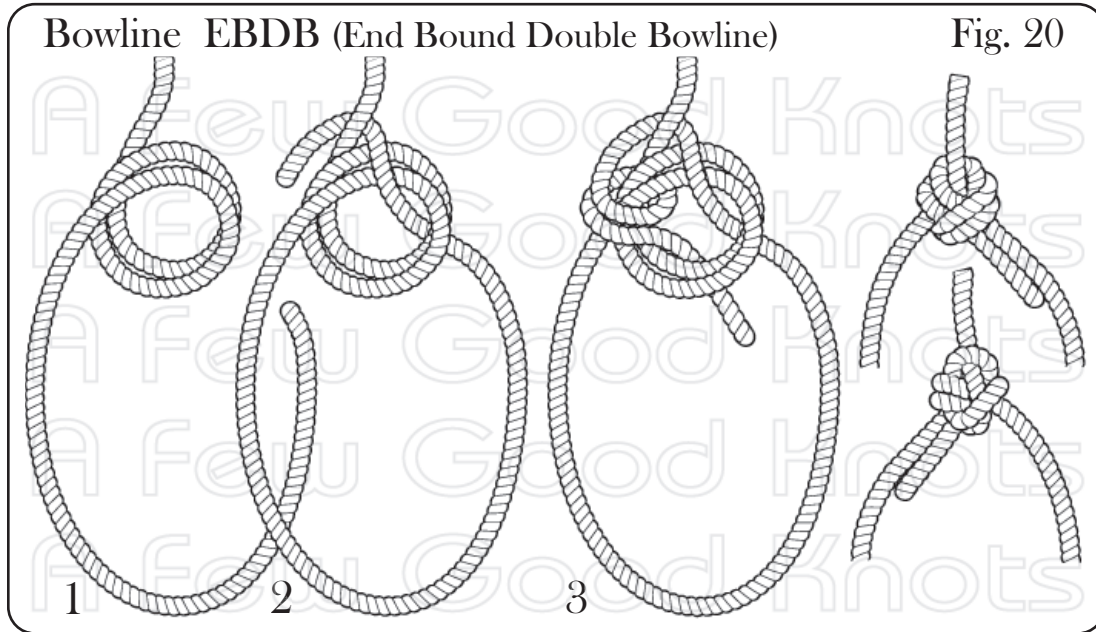

**The EBSB +Y Bowline**, End Bound Single Bowline plus a Yosemite finish, was developed not only to be more secure but also to resist [Ring Loading](#) and consequently reinstate the Bowline as a prominent climbing knot.

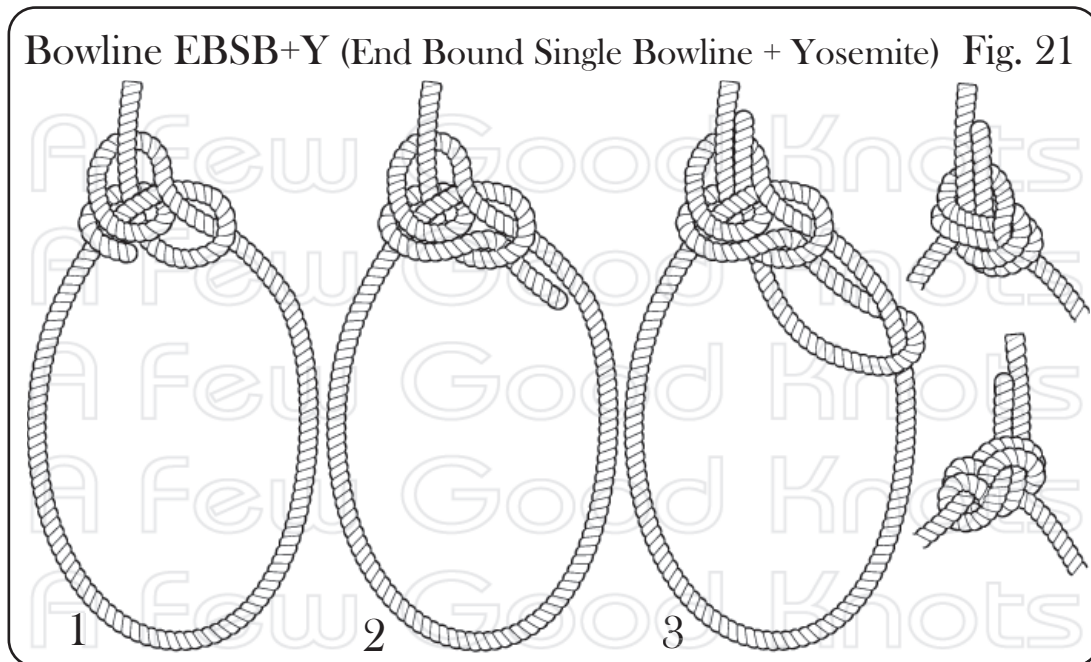

**Lee's Locked Bowline** is considered the best variation of the Single Bowline (ABoK # 1010); it is not only secure, but also easy to tie and check and is additionally impervious to [Ring Loading](#).

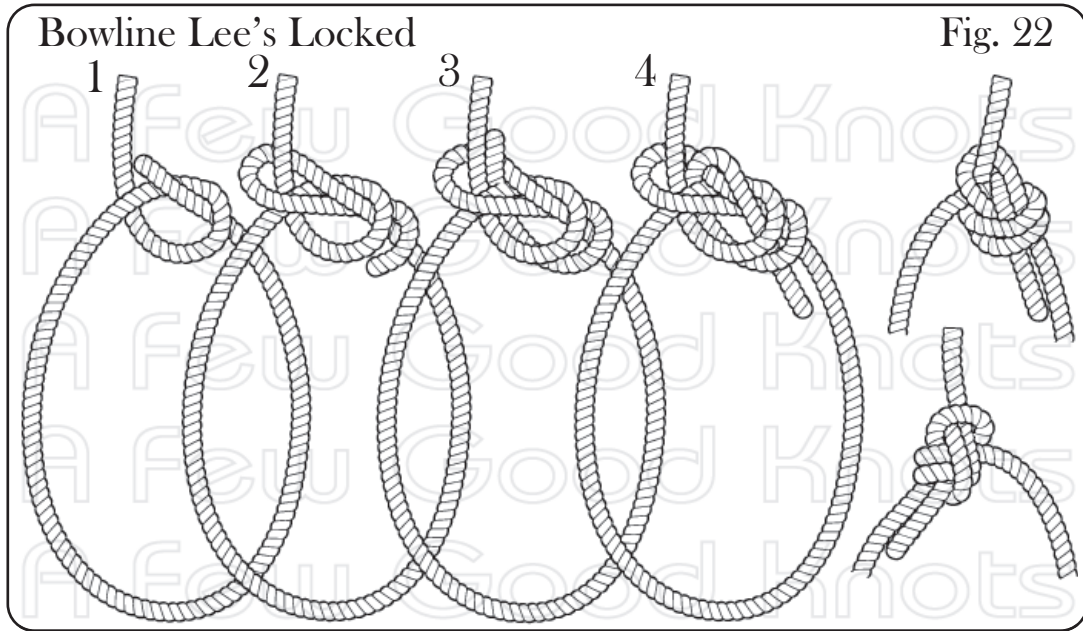

**The Bowline on the Bight** (ABoK # 1080) is a traditional Double Loop Knot that is both secure and easily tied.

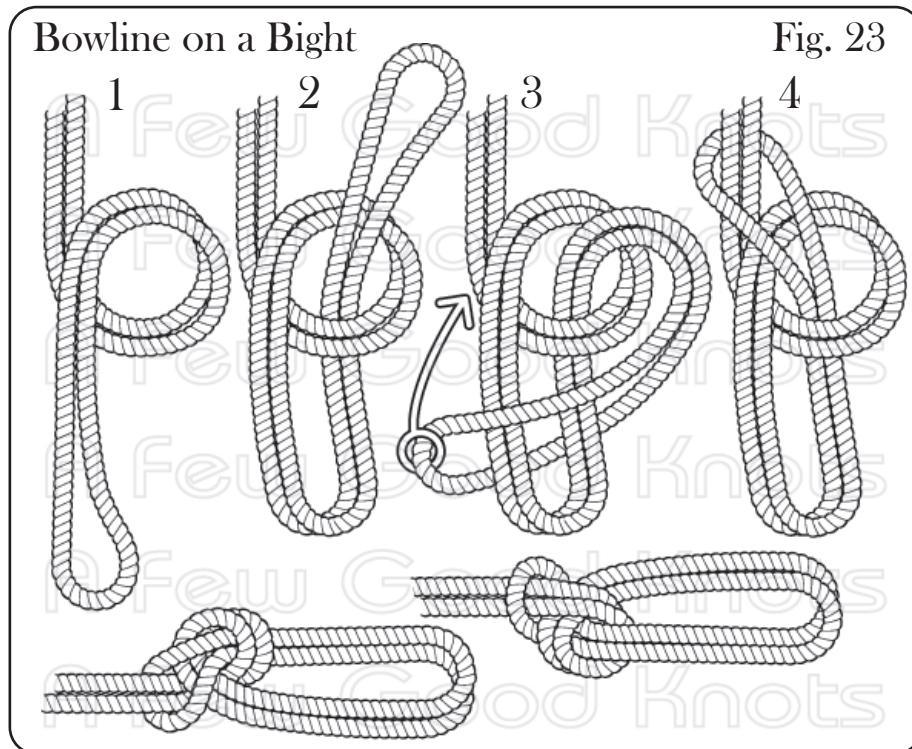

**The Spanish Bowline** (ABoK #1087) is one of the Classic Chair Knots, used extensively at one time to hoist people at sea and until recently in rescue operations. Now superseded by safety harnesses. It remains a beautiful knot.

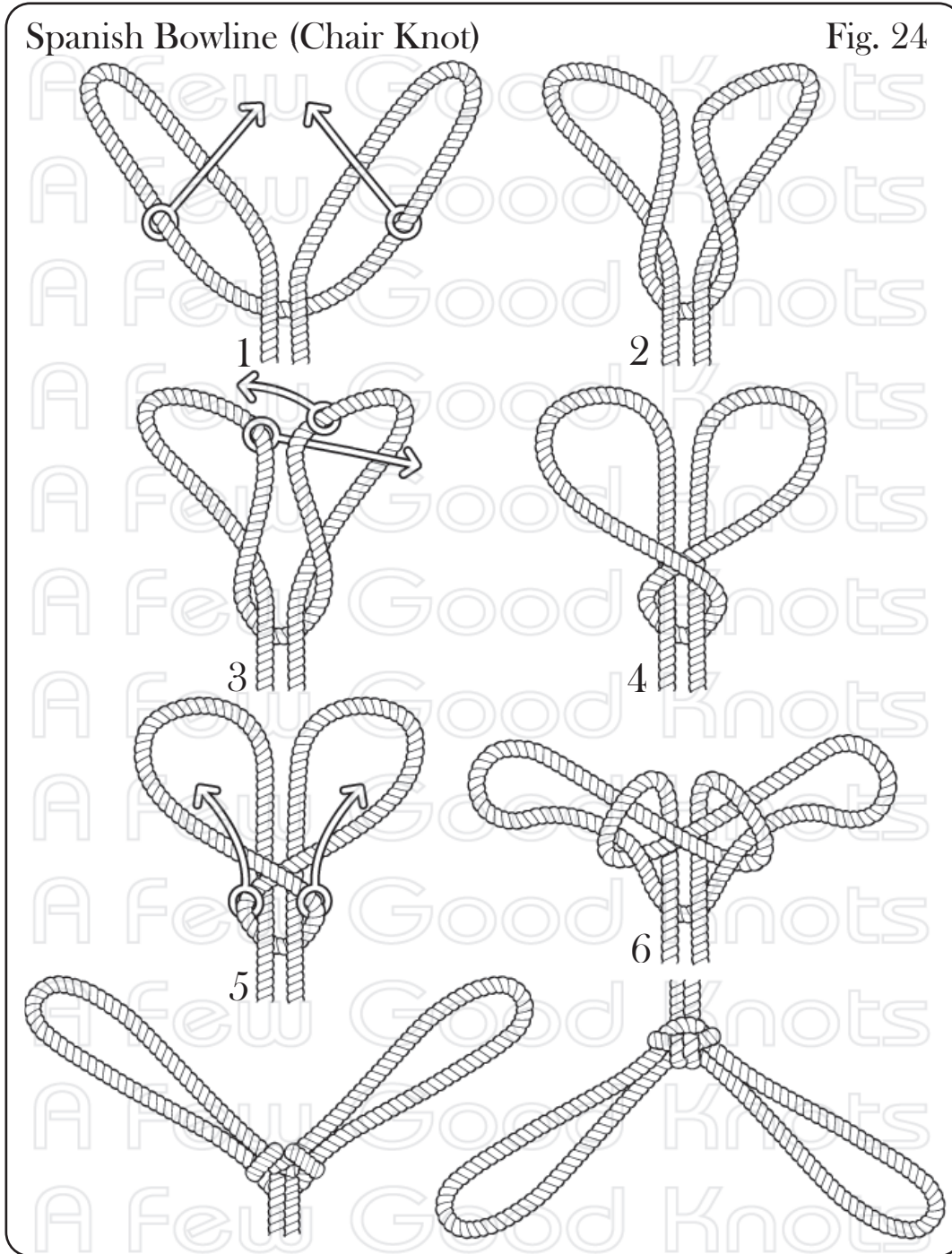

Bowline Eskimo Fig. 25

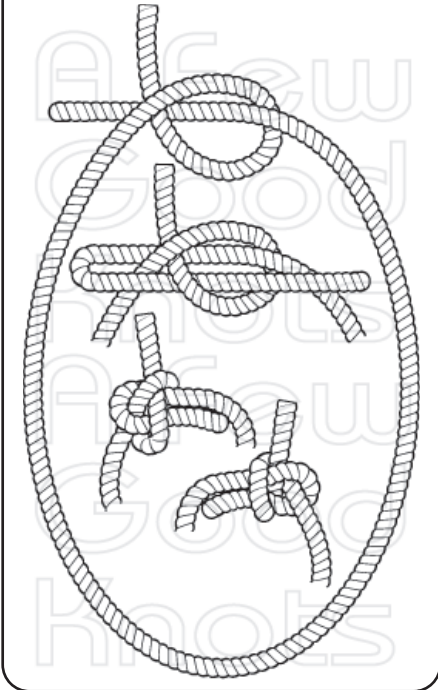

**The Eskimo Bowline** is an unusual bowline, the first examples of which were found on an old Inuit sled collected in 1818. Its unusual construction – The Working End goes down through an Overhand Loop (rather than up) and under and around the Leg (rather than the Standing Part) and then back up the Overhand Loop – make it of interest. Curiously it is particularly immune to Ring Loading. It is reputed to be more secure than the Single Bowline (ABoK 1010) but not of its variations.

### Ring Loading

What is *Ring Loading*? Well, if a loop knot were a mouth, it is as if one were to grab it by the sides and attempt to pull it inside out. Although some Loop Knots can withstand these forces better than others, they are not supposed to be abused in this way.

This loading can arise if a Loop Knot is tied too closely around very wide material, say 8 x 4 foot sheets of plywood for example, however, most cases amongst climbers are due to incorrect equipment attachment. The name originates from treating the loop of a rope as if it were one of the metal rings specifically designed for these stresses.

Ring Loaded Rope Loop Fig.26

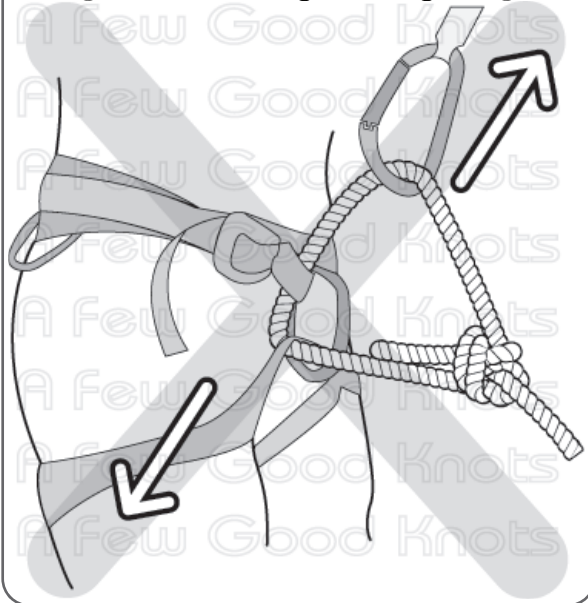

**Fixed Loops continued...**

**The Double Figure Eight Loop** (ABoK # 1085), along with the single **Figure Eight Loop** (ABoK # 1047) and its very useful doppelgänger the **Re-Threaded Figure Eight Loop** are three members of the important family of Figure Eight Knots which include the [Directional Figure Eight](#), the [Figure Eight Bend](#) and the [Figure Eight Stopper Knot](#) as well.

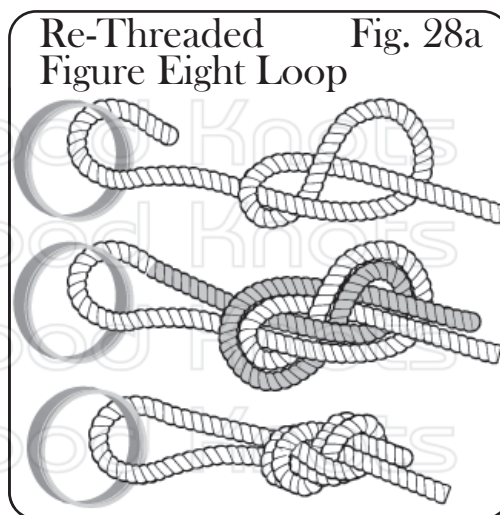
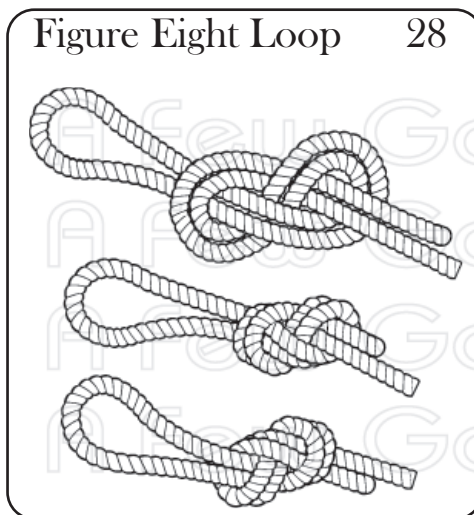
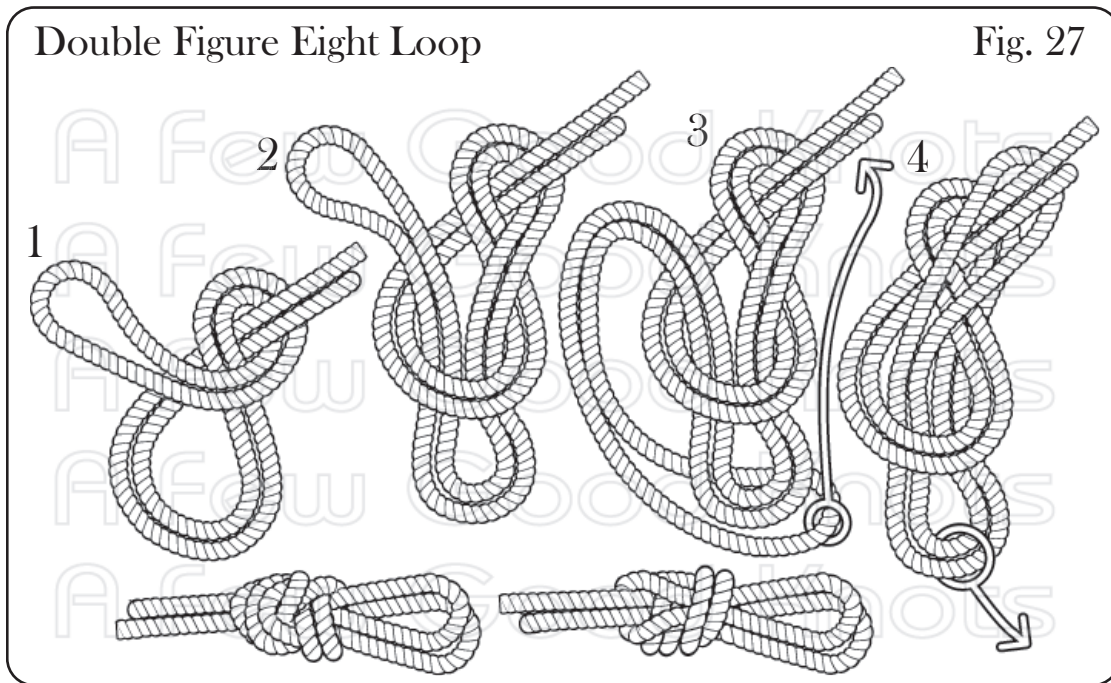

**The Directional Figure Eight Loop** (ABoK # 1058) is tied in the bight. It is a secure loop to use when the direction of pull on the loop is known and consistent. It is often used as the Standing Part Loop in the [Waggoners Hitch](#).

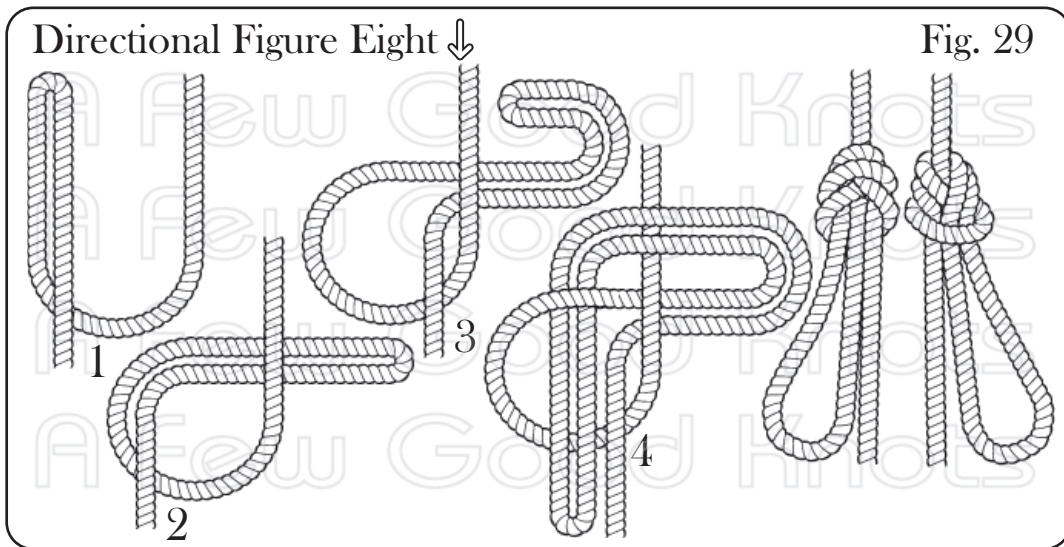

Note how the tying methods are mirror images of each other when the Loop runs in the opposite direction.

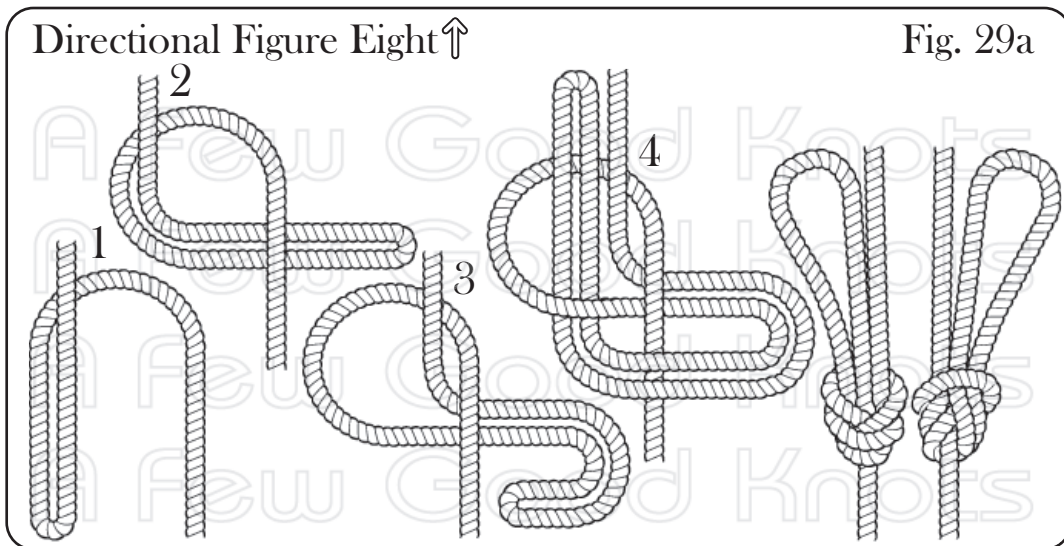



**The Alpine Butterfly** (*Lineman's Loop*) (ABoK # 1053)

This knot, which is also tied in the Bight, has the additional virtue that it remains secure when pulled from any direction. This makes it a favourite with climbers, who value it highly.

The Alpine Butterfly can also be used in an emergency to bypass a weakness in the rope; the knot is tied so that the weak section is part of the loop.

This is only a stopgap, to be used until circumstances allow the rope to be cut and either joined with a bend or spliced. Ideally, though dependent on the extent of the damage, the rope should be replaced.

There are several methods of tying the Alpine Butterfly; the one shown is in the author's opinion one of the easiest.

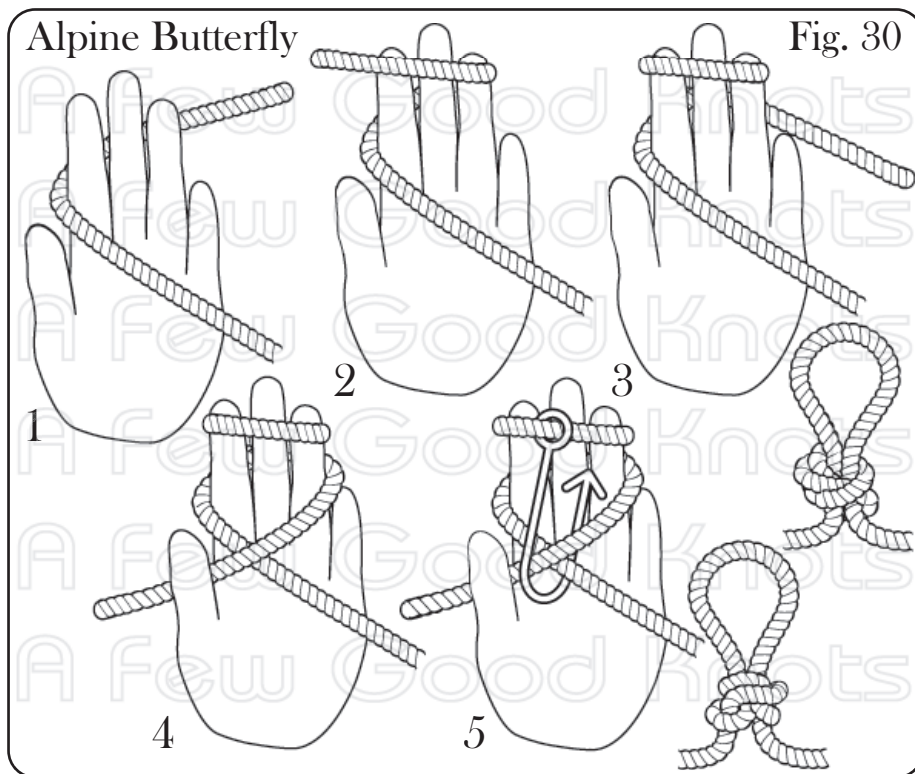

## The Noose

**The Simple Noose** (ABoK # 1114) can be formed either by feeding a bight through from below the overhand loop (see Fig. 31), to use say, in the [Waggoner's Hitch](#), or by feeding the bight from above the overhand loop (see Fig. 31a), to use as a snare or a general-purpose noose. Placing a toggle through the noose in Fig. 31a, forms a **Marlin Spike Hitch** (ABoK # 1789).

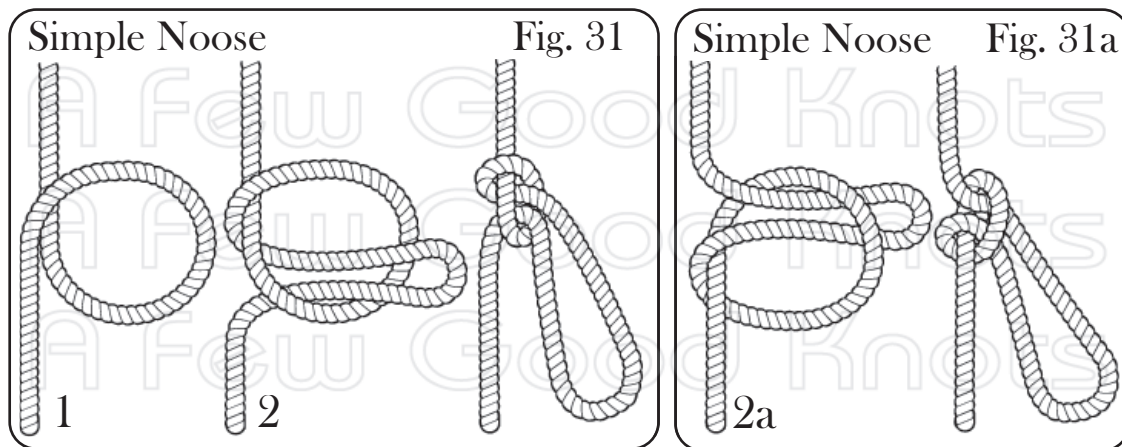

## Poacher's Knot (*Scaffold Knot*) (ABoK # 409)

It is tied with either a Double (as a snare) or Triple Overhand Knot (a strong general purpose Noose). Its alternative name, a use which probably required an additional turn or two, speaks for itself.

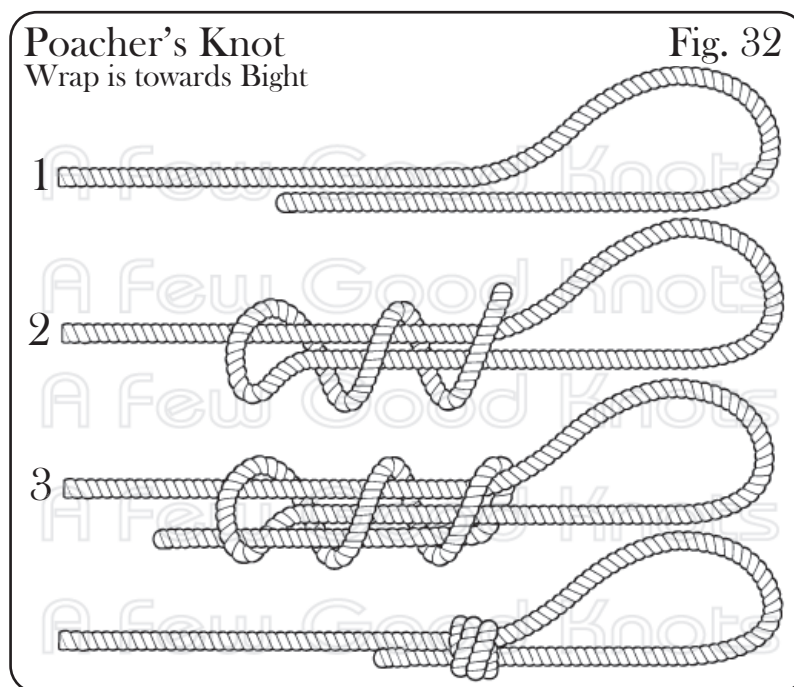

## Bends

Bend refers to a knot that joins two ropes.

### Zeppelin Bend

If the ropes are the same diameter, or very nearly, the Zeppelin Bend is an excellent choice. It is very secure, does not jam, and once learned is also a fast and easy knot to tie.

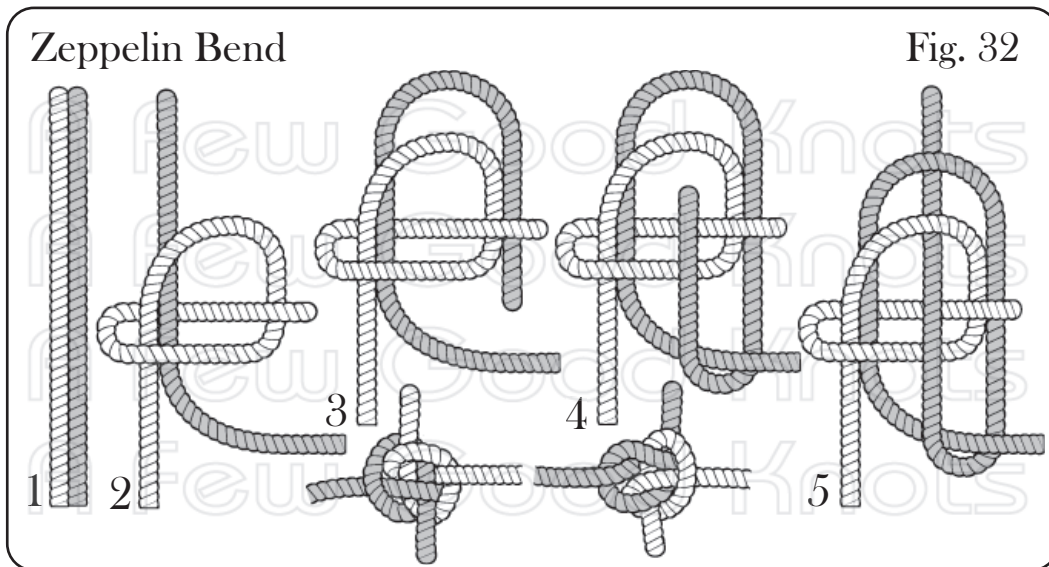

Some climbers however prefer to use the Flemish Bend (also known as the Figure Eight Bend), others favour the Double Fisherman's Knot, particularly if making slings, despite the difficulty in untying overhand knots.

### Flemish Bend (*Figure Eight Bend*) (ABoK # 1411)

This knot, as does the Figure Eight Loop, ([see Fig. 28 and 28a](#)), needs to be dressed before tightening in order to avoid crossed lines.

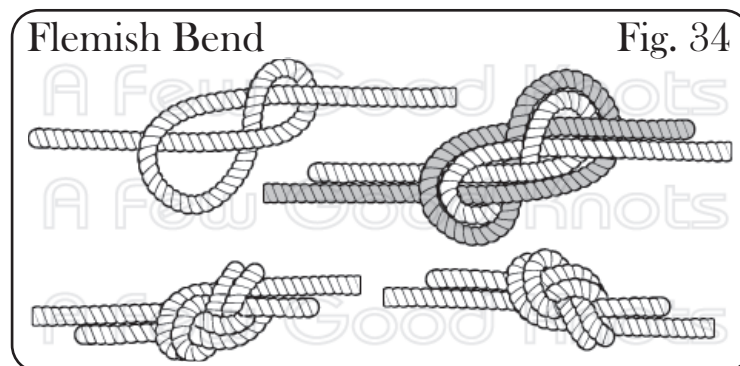

**Double Fisherman's Knot** (*Grapevine Knot*) (ABoK # 1415)

To limit abrasion and lock-in the knot, it should be tied so that when the two knots are joined there are parallel wraps on one side and the characteristic Xs on the other. It should be noted that one extra turn on each side before threading the end through, forms the Triple Fisherman's Knot.

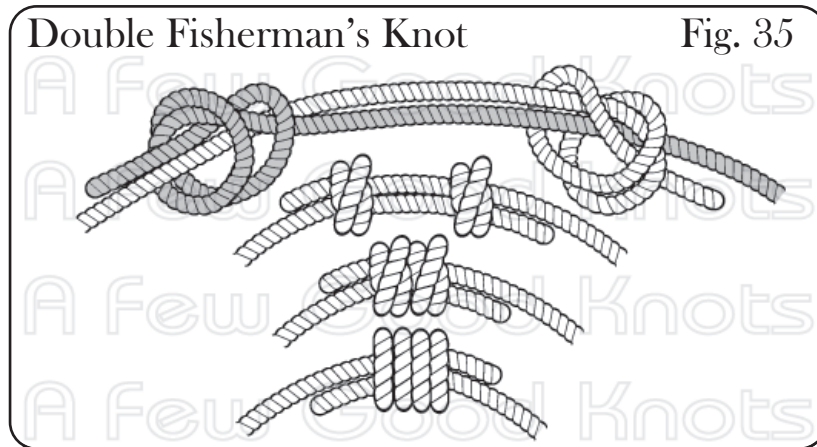

**The Water Knot** (*Ring Knot*) (ABoK # 1412)

This bend is little used on rope; it is however a practical knot with which to join webbing and straps, particularly if left with long tails.

The Tails can subsequently be secured if needed.

The knot consists, in actual fact, of a Re-Threaded Overhand Knot.

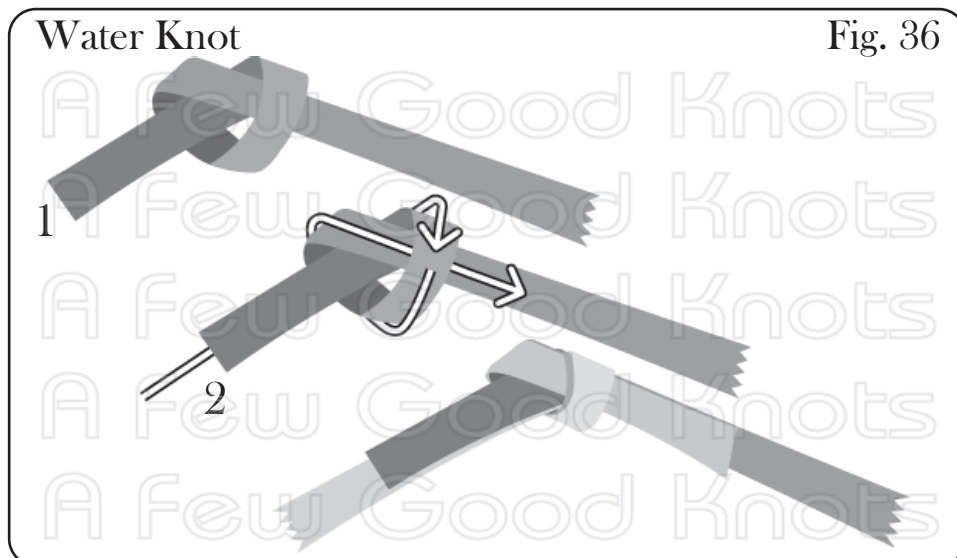

## The Carrick Bend (ABoK 1439)

If the ropes are very stiff and therefore difficult to wield and tie, such as large diameter hawsers or wire rope, then the **Carrick Bend**, which consists of **two interwoven underhand loops**, is the bend of choice.

Because of the stiffness and weight of the hawser/wire rope, this bend is best tied on the ground. Start by placing both ropes parallel to each other with sufficient overlap to complete the knot and allow for long tails.

Make an underhand loop with one of the ropes and lay it over the other rope (see Fig 37 #1). Start the weave by first laying the other rope's Working End **over** the underhand loop's Standing Part (See Fig. 37 # 2). Work your way around tucking the Working End under and over each successive strand, until you complete the second underhand loop (See Fig. 37 # 6).

**Note:** This Bend is best checked before tightening, as its final form depends on the stiffness of the rope and the amount of tension applied.

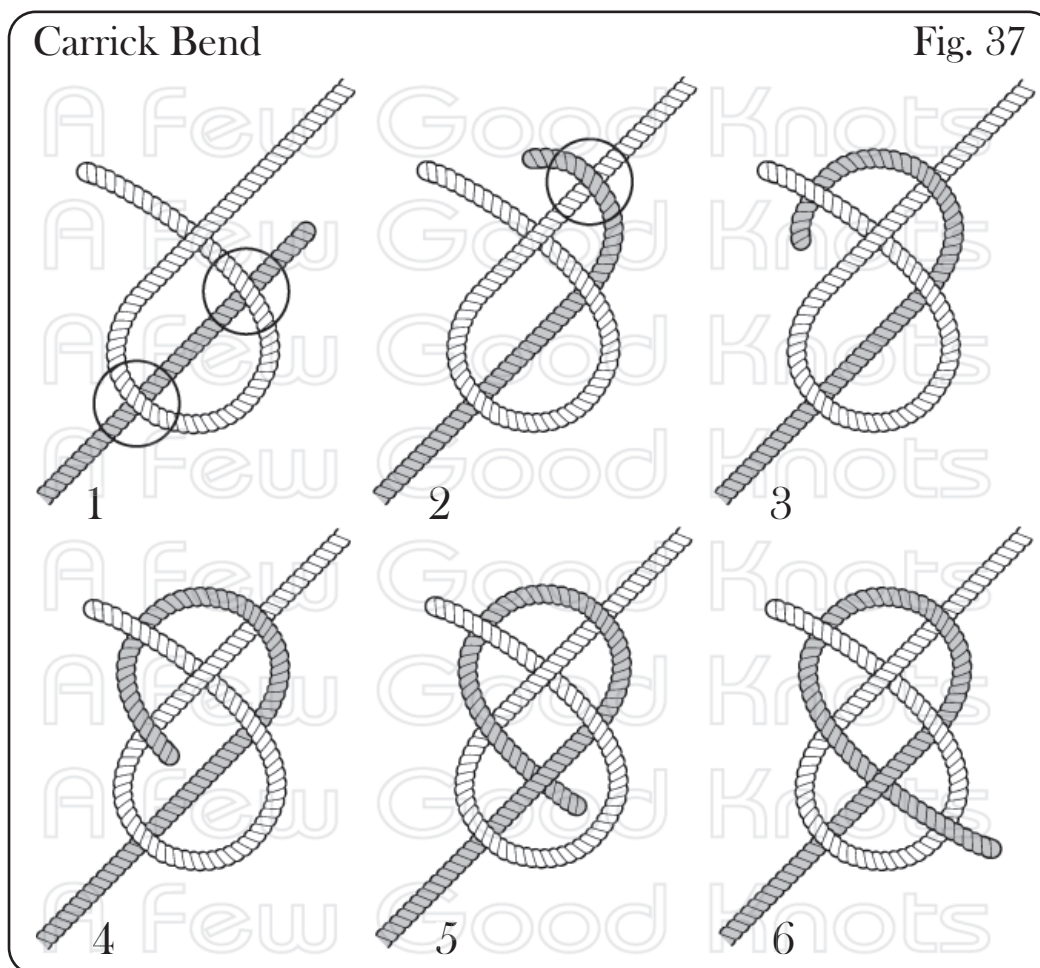

If the ropes are of different diameters the Single Sheet Bend, or alternatively the Double Sheet Bend make a good temporary bend.

**Sheet Bend (ABoK # 1431) & Double Sheet Bend (ABoK # 1434)**

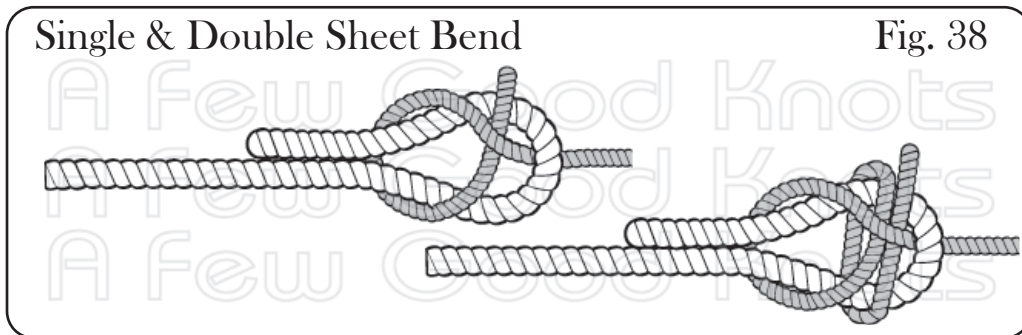

**Seizing Bend**

The Seizing Bend however is much more secure, and therefore better as a longer-term solution.

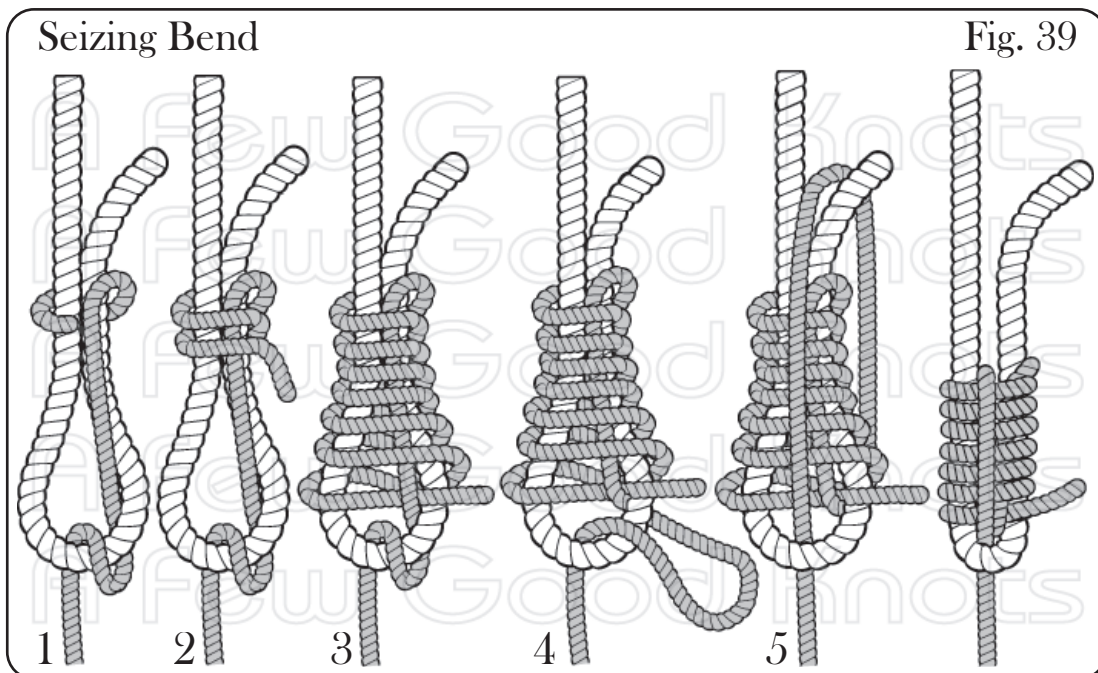

## Binders

### **The Reef Knot** (*Square Knot, Flat Knot*) (ABoK # 1402)

This classic knot is best used to bind a package, bundle or bandage. It should be flat against the object it is binding.

The origin of this knot as its name suggests is in the reefing of sails. It has two properties that are useful in this, it holds the bundled sails firmly and yet is easily untied by pulling the ends back on themselves.

It is this characteristic that makes it unsuitable as a bend.

The Reef Knot is one of the instances where the difference between Overhand and Underhand matter. It consists in either two consecutive Overhand or two consecutive Underhand Half Knots\*.

A combination (mixing them) produces a Granny Knot.

The key to tying a Reef Knot lies in recognizing that though one is working with two ends, only one of them is the Working End.

Keep clear which is which and Granny Knots are a thing of the past.

If still in doubt use one of the mnemonic devices:

e.g. *right over left and under, left over right and under.*

\*When an Overhand or Underhand Knot is used in a Binder or other knot (see Fig. 3 Image # 2) it is referred to as a Half Knot.

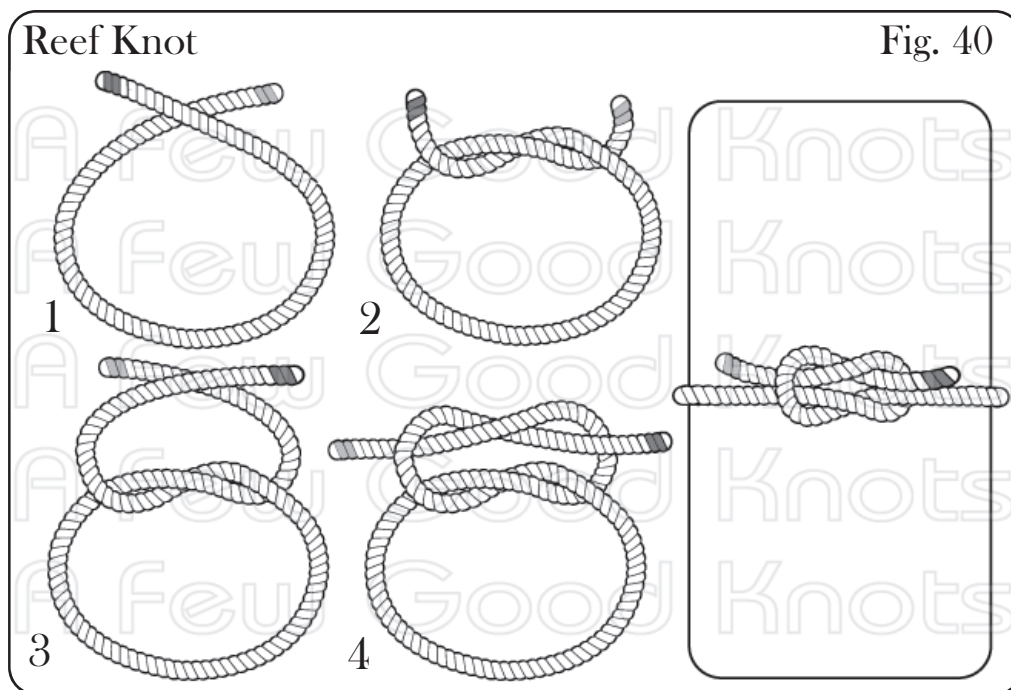

**The Constrictor Knot** (ABoK # 1189) is a very secure binding knot that can be made with either the Working End or in the Bight. When made with the Working End it mirrors the Clove Hitch (see Fig. 6a), apart from an additional tuck under the bottom turn (see Fig. 41 # 4).

The Constrictor can sometimes be difficult to untie in thin cord or twine; in such cases, carefully cutting the top strand is on occasion the best option.

Constrictor Knot (tied with the Working End) Fig. 41

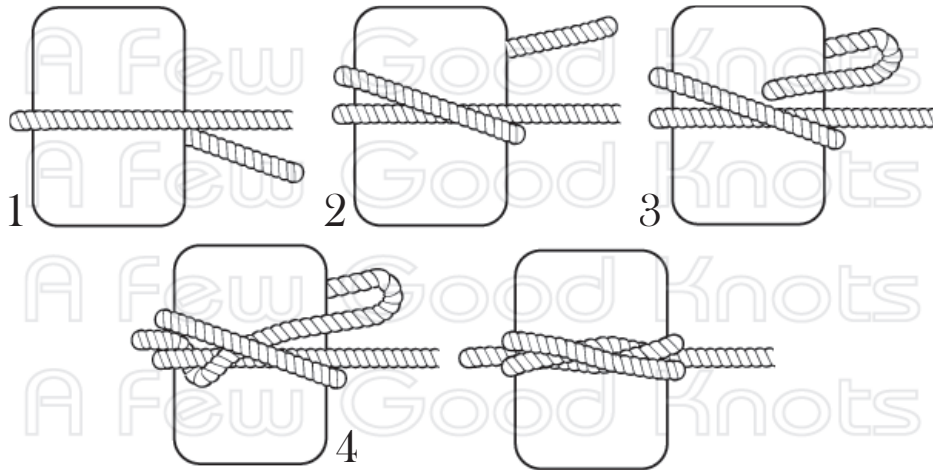

Constrictor Knot (tied in the Bight) Fig. 41a

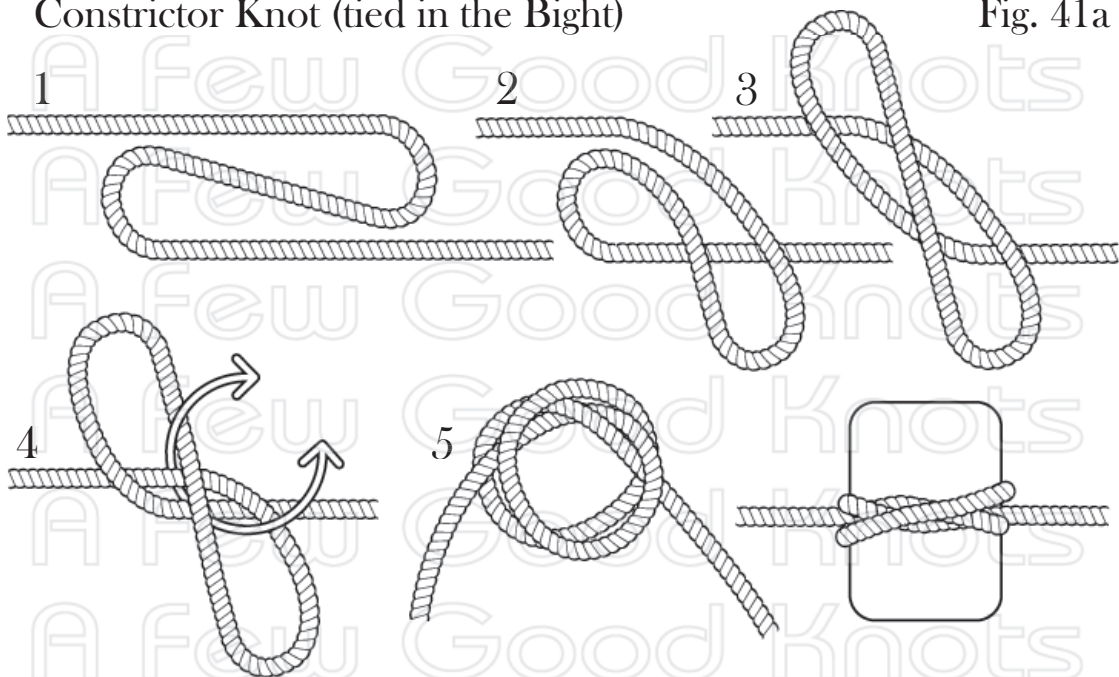



### The Strangle Knot (ABoK # 1239)

This knot is a near universal binder, much used for temporary binding.

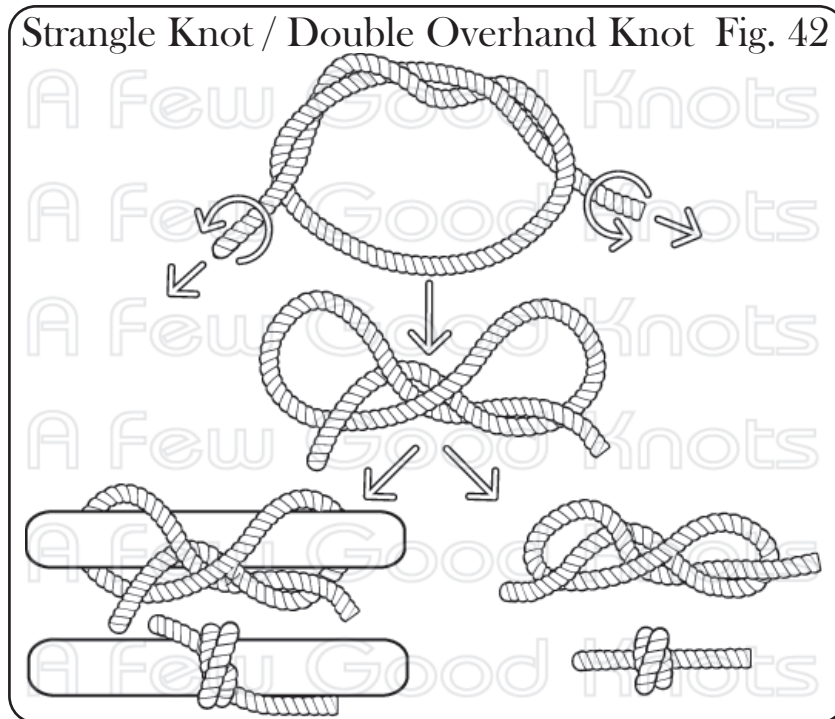

With this tying method (see Fig. 43), additional turns can be added to the Strangle Knot if required, broadening its use to include [Whipping\\*](#) or providing additional security to other knots such as the [Re-Threaded Figure Eight Loop](#), in which the tail is secured by tying it to the Standing Part.

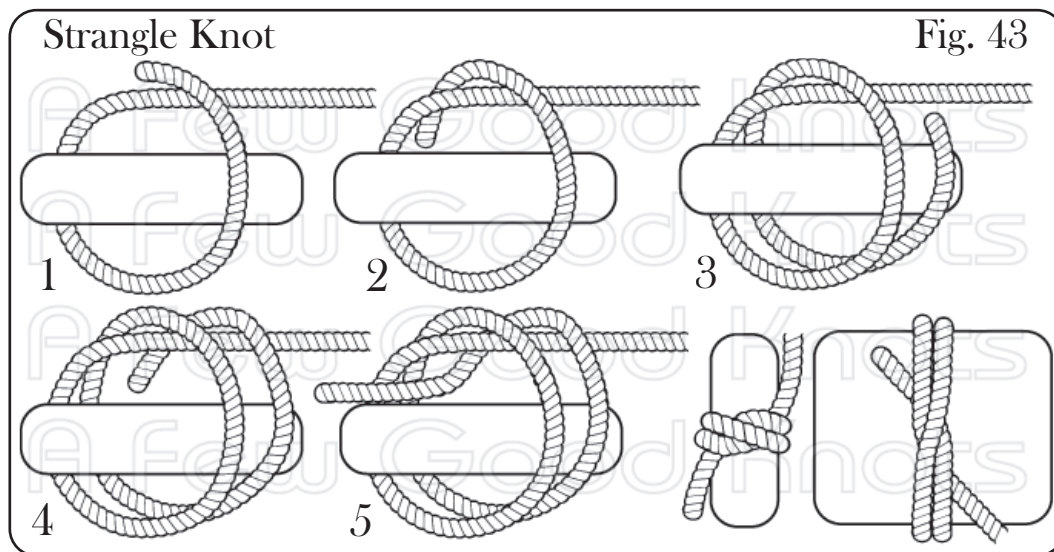

## The Gleipnir

This is an interesting new binder with the added virtue that it does not need to be in contact with a surface to hold. It does however require that there be a degree of slippage of the rope around the object to be bound in order to allow the loop to close and grip the ends.

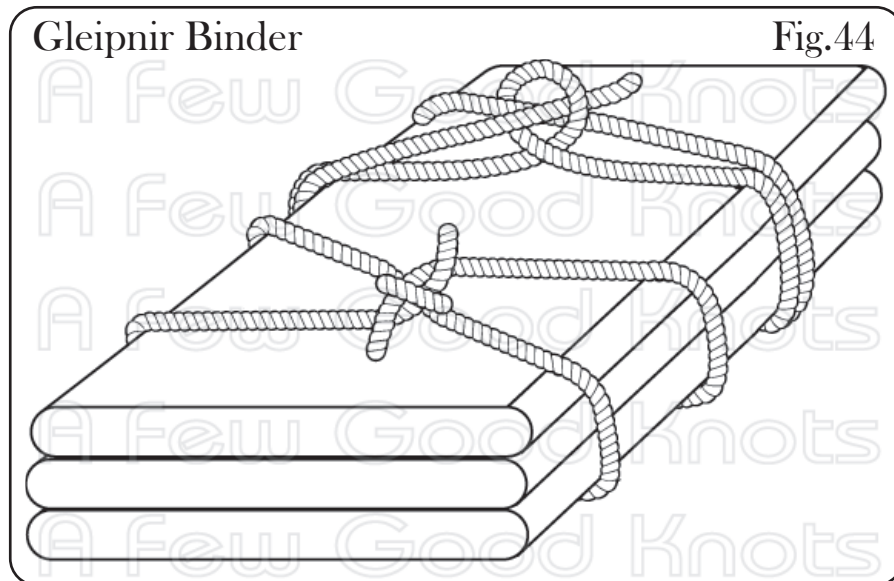

**Pole Lashing** is an efficient way to bundle poles, spars, staffs or insubordinate umbrellas. It is finished off with a [Reef Knot](#).

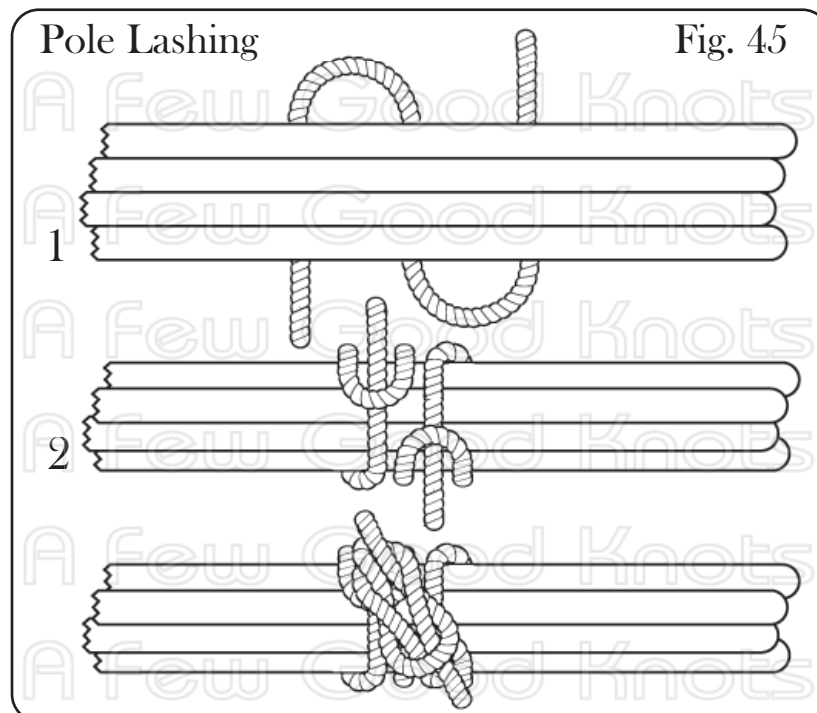

## Stopper Knots

**Stopper Knots** are used for a variety of tasks, from holding up a shelf or attaching a swing, to preventing the rope from unreeving from a block, slipping through a Cam Cleat or running out of a belay/abseil device. Similarly, they can also provide security to a knot by preventing the Tail from pulling through. They are equally useful in providing handholds on a rope that is being pulled or climbed.

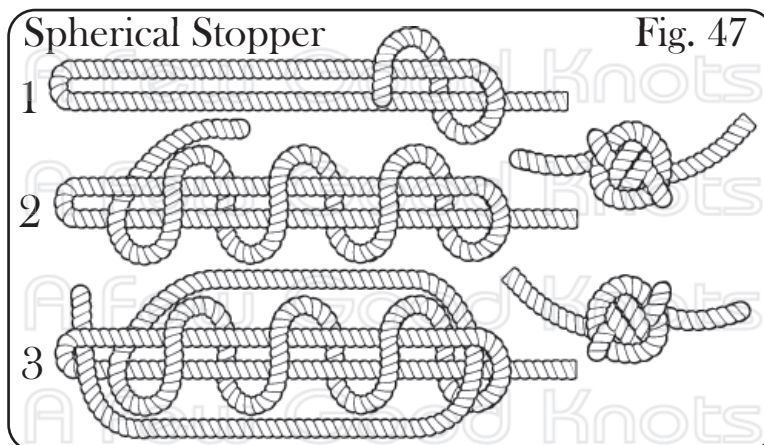
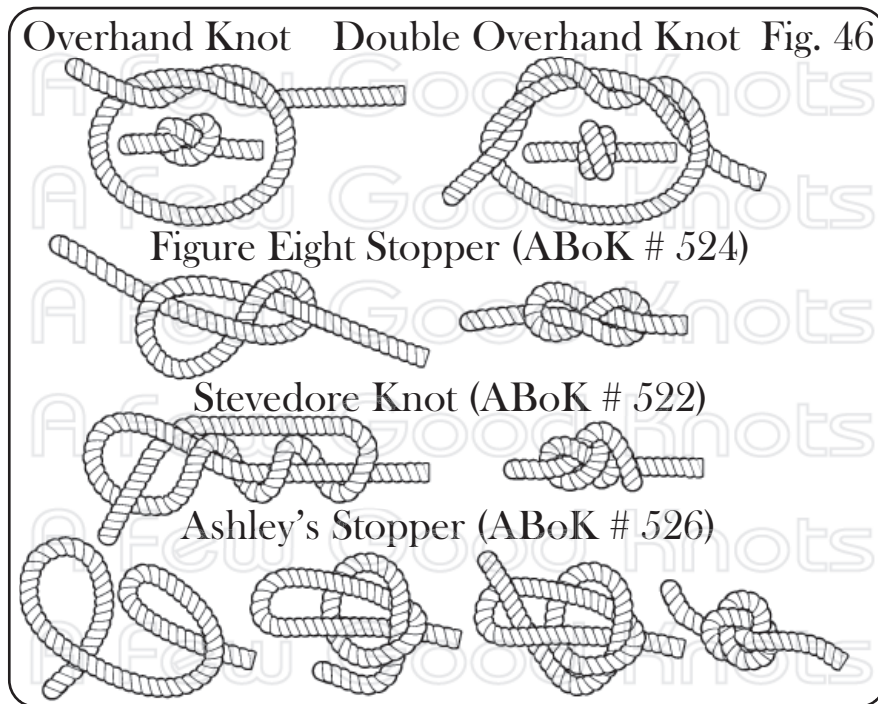

**Multiple Overhand Knots** can be tied on a rope's own standing part as in Fig. 48 and 49, however, when they are tied over another rope or object, (see Fig. 43) they are technically known as a Strangle Knot.

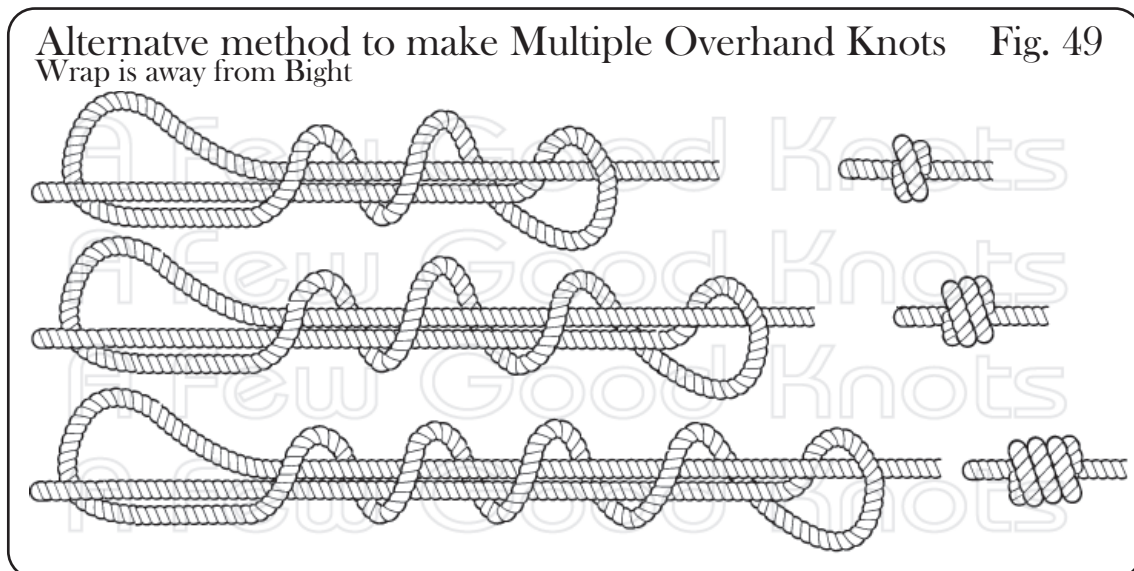
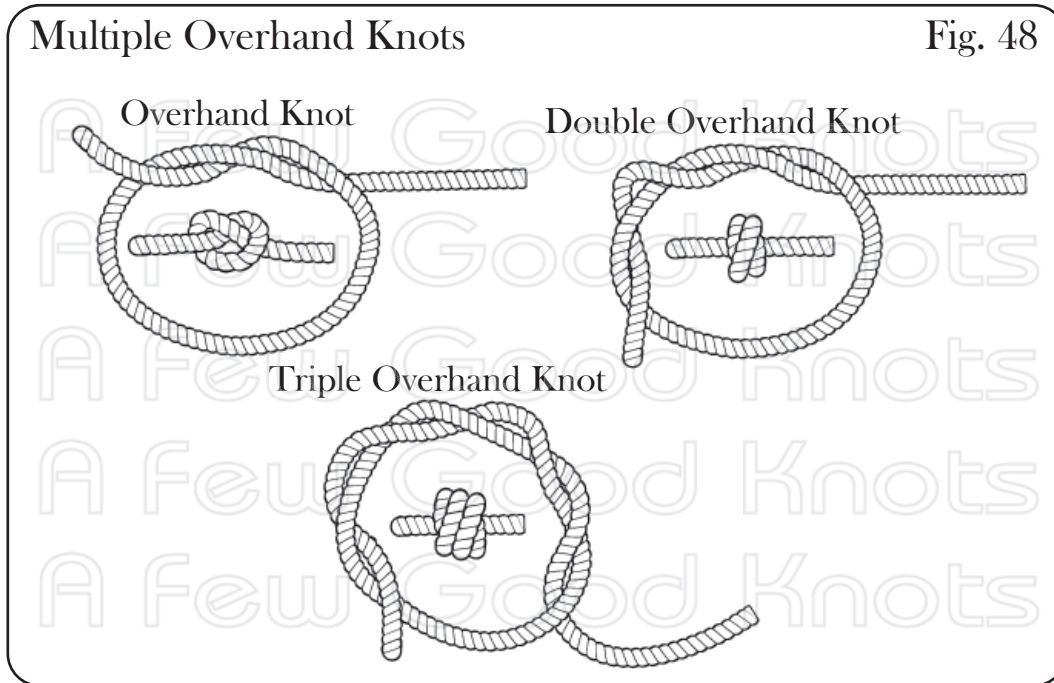

## Friction Knots

Friction Knots or Slide and Grip Knots as they are also known are specialized knots; as such they tend to fall within the province of climbers, cavers and arborists.

They are mainly tied using slings made of webbing or cord.

The cord used is usually between 60% and 70% of the diameter of the rope it is to be tied around. A smaller diameter cord has a longer footprint (more surface area contact) than a same sized rope; in practical terms that means one can achieve the same amount of grip with less wraps.

The cord sling, generally known as a Prusik Sling, is fastened with either a Double or Treble Fisherman's Knot (see Fig. 35).

In Friction Knots it is important that the knot itself should only be grasped in order to slide the knot, as pulling or pushing it, loosens it. This holds true for Friction Knots tied in single cord as well as slings. Slings should only be loaded at the bottom, and never held by the knot that joins them.

The number of wraps needed to achieve the friction necessary to hold a given weight depends on the material of the rope and cord, their comparative size and the conditions at the time, such as water, mud, ice etc...

**The Prusik Knot** (ABoK # 1763) Though known and used at sea for many years, it revolutionized climbing technique when introduced to the world of mountaineering in 1931, after the Austrian Alpine Club published it.

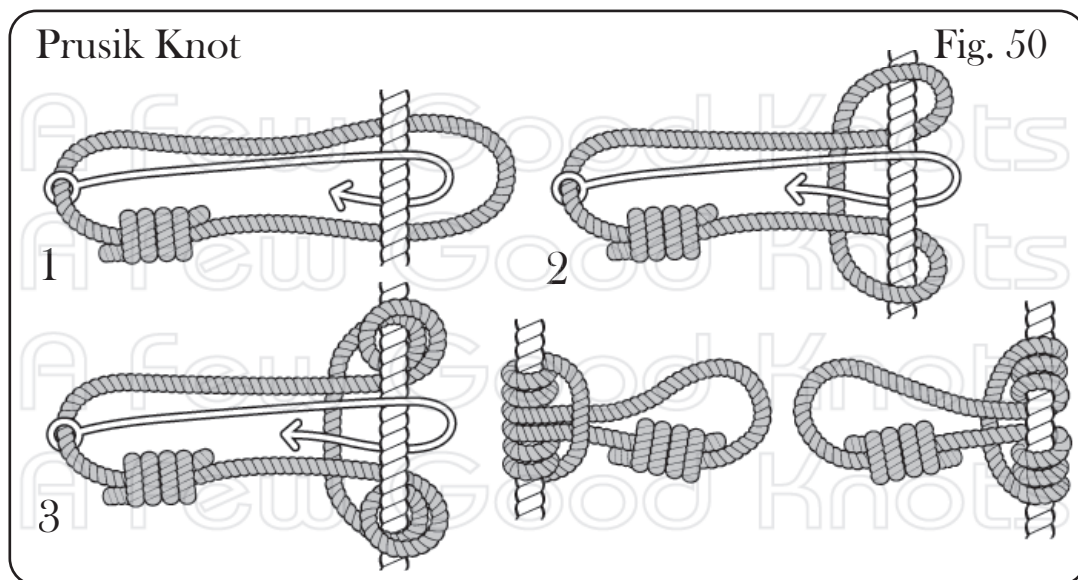

**The Klemheist Knot** (*Machard*) (ABoK # 1762) This popular Friction Knot was also used at sea, however, it owes its present reincarnation as a variation of the Prusik Knot.

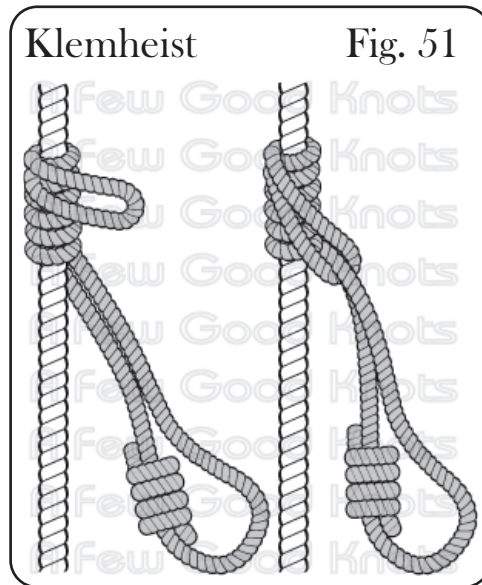

**The Hedden Knot** is the inverse of the Klemheist, it is reputed to be as secure despite utilizing considerably less wraps.

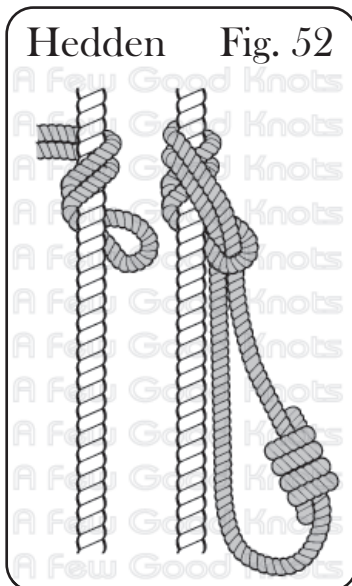

**The Bachmann** is a variation of the Klemheist that is tied around a Karabiner – its function is to help avoid jamming due to over-tightening.

The Karabiner is not to be used as a handhold.

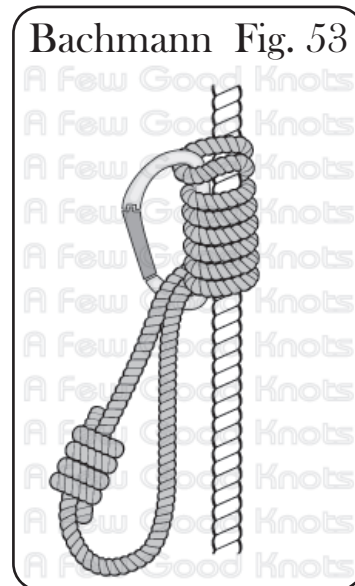

**The Prohaska # 1** (*Blake's Hitch*) is designed to be tied with single cord or single webbing.

**Note:** It is recommended that the working end be secured with a Figure Eight Stopper Knot.

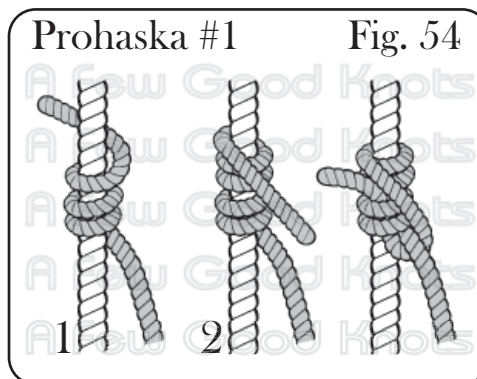

**The Prohaska # 2** is shown here tied with a Prusik Sling. It works equally well with a webbing sling and can also be made in the Bight.

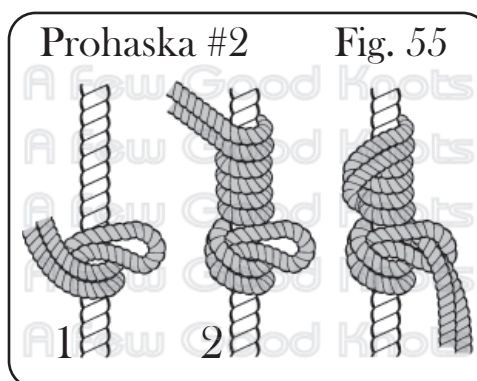

**The Prohaska # 2** can also be tied in either single cord or single webbing.

**Note:** It is highly recommended that the working end be secured with a Figure Eight Stopper Knot.

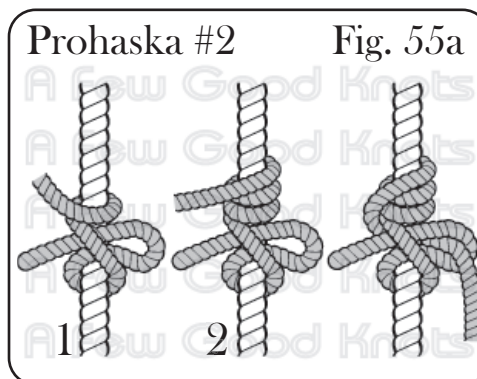

## Slings and Recovery Straps

Both Slings and Recovery Straps have to be joined on occasion; there is only one way of joining them correctly and two methods to achieve this: A and B.

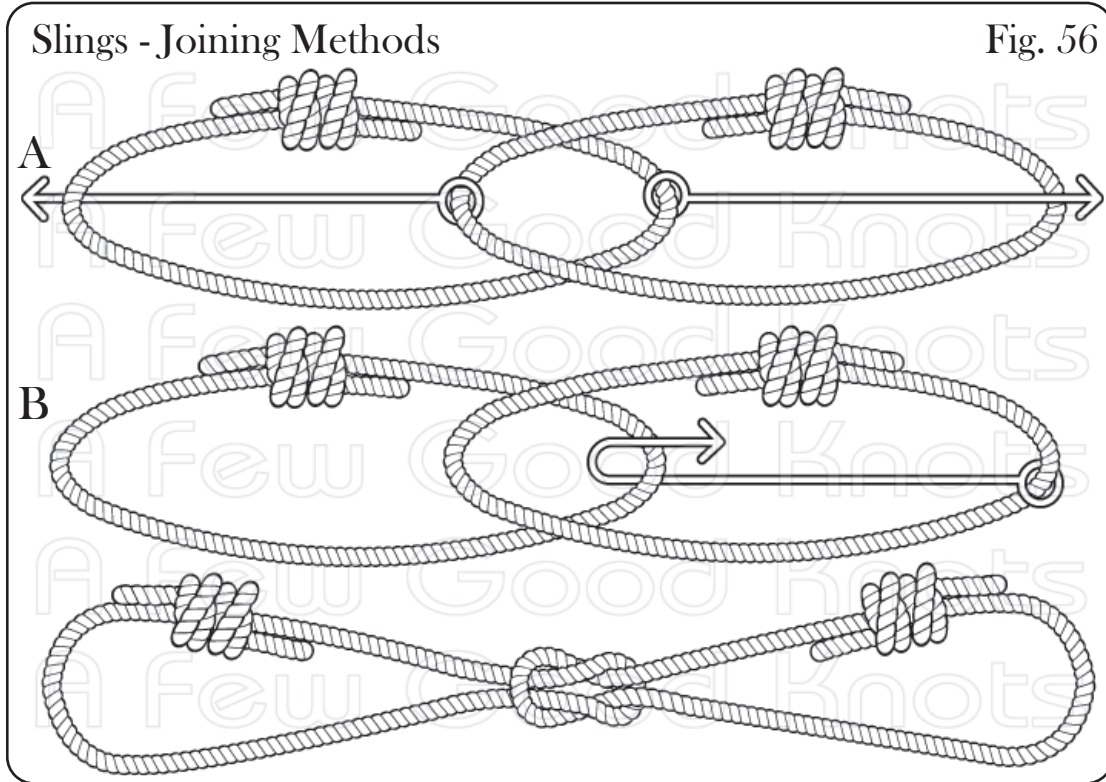

Due to the large forces involved during a vehicle recovery, placing a rolled towel or newspaper as pictured assists untying.

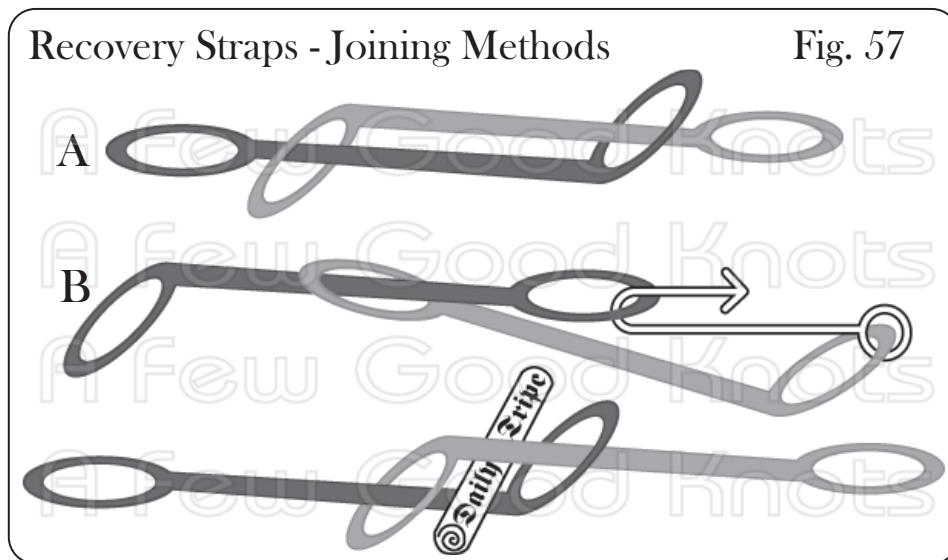



## Lashings

**Lashings** are used to secure poles together. They can be used to create temporary shelters, scaffolding, trellises, grape arbours and the like.

Care should be taken to make the lashing as tight as possible.

The Frapping Turns (see Fig. 58 # 5, Fig. 59 # 5 and Fig. 60 # 3), which go between the poles, pull the previously tightly laid wraps tauter.

**Square Lashing** (Fig. 58), which starts and finishes with a **Clove Hitch**, tends to be used when the poles are angled at or around 90° degrees, while the **Diagonal Lashing** (Fig. 59), which starts with a **Timber Hitch** and finishes with a Clove Hitch, can be used to lash poles at up to 45° degrees.

If the angle is smaller then a **Shear Lashing** (see Fig. 60) should be used. The simplest method is to make several turns, about 10, around both poles (Wraps), and then a couple of turns between the poles (Fraps). Start and finish with a Clove Hitch on alternate poles. If the Lashing is not quite tight enough, wedges can be hammered in parallel to the poles.

### Square Lashing (ABoK # 2114)

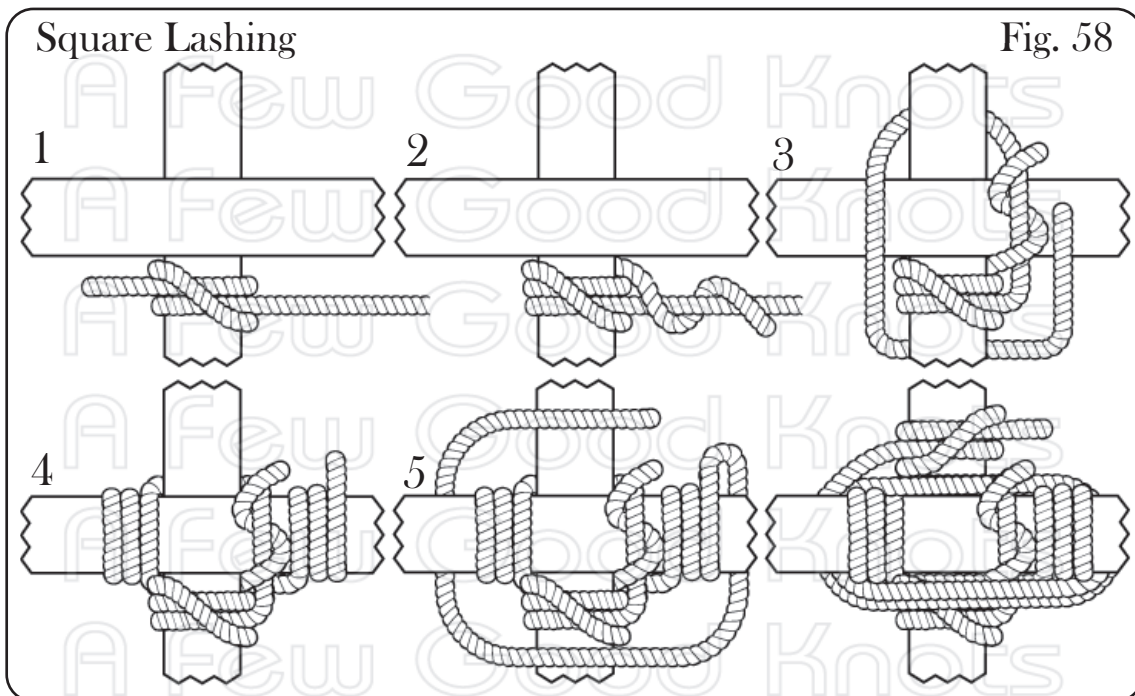

## Lashings

### Diagonal Lashing (*Crossed Lashing*) (ABoK # 2115)

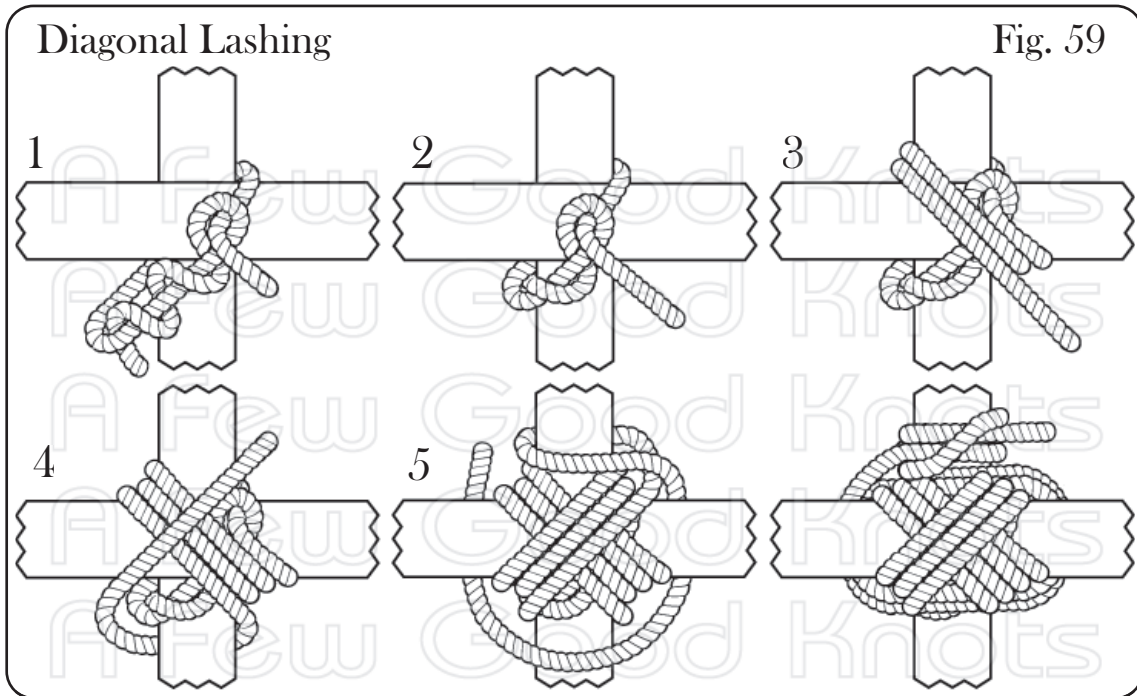

### Shear Lashing (ABoK # 2102)

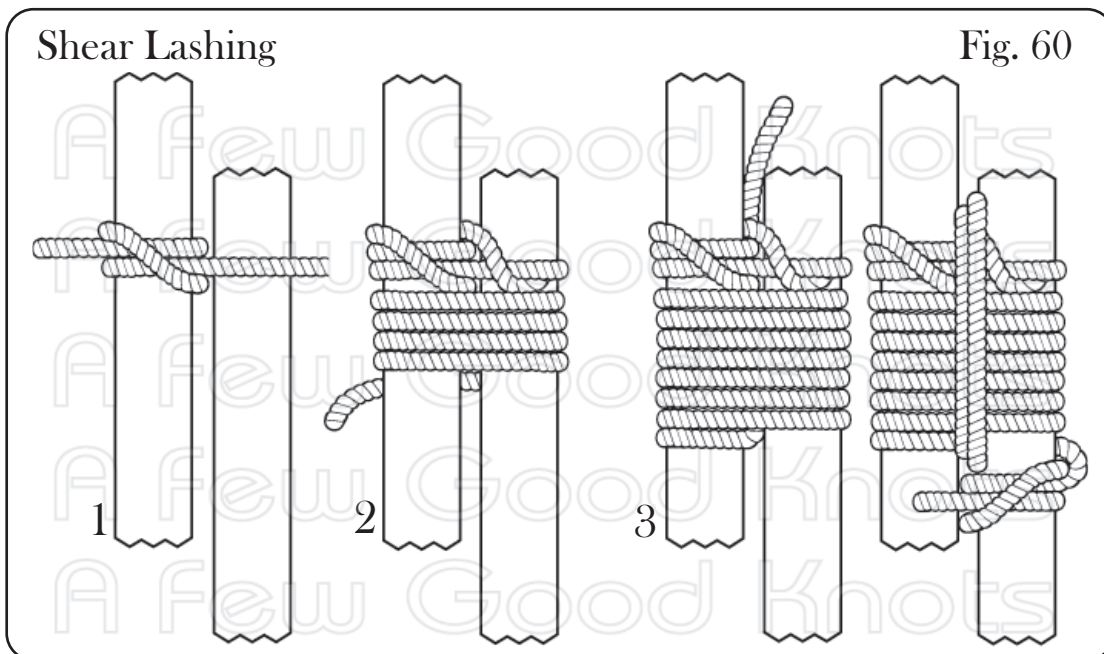

## Whipping

Whipping is really only necessary on natural fiber rope. Synthetic rope is best heat sealed. If it were needed, the rule of thumb for whipping is fiber twine for fiber rope and synthetic twine for synthetic rope.

\* The diameter of the twine should be  $\frac{1}{8}$  of the diameter of the rope that is to be whipped, and the whip should be the length of the diameter of the rope.

**Common Whipping:** Lay the twine in a loop over the rope, leaving a space of about half the diameter of the rope clear, then wrap tightly towards the bight until the length of the whip is the same as the diameter of the rope. Pass the Working End through the Bight, then pull the Standing Part until both the Bight and the Working End are pulled under the wraps. Trim the Standing Part flush with the first wrap.

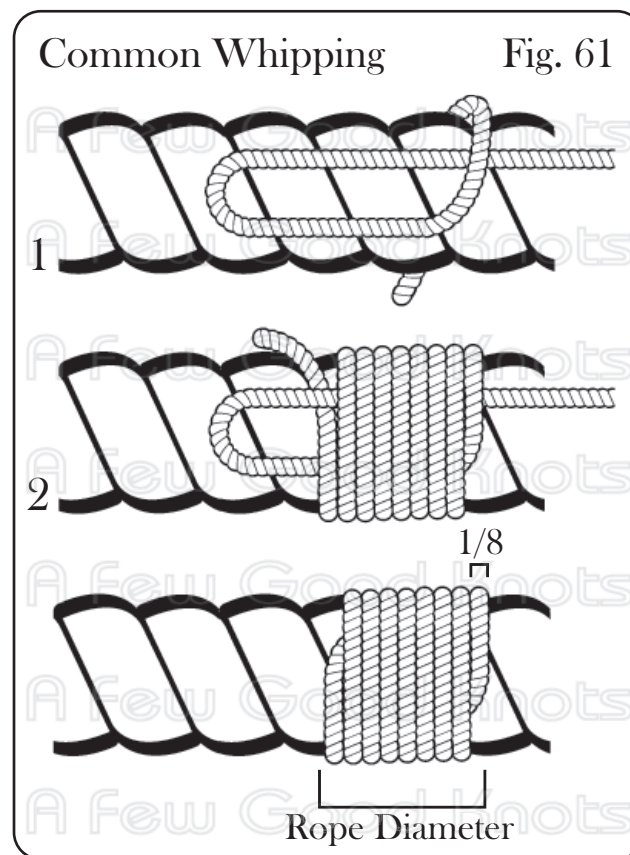

<b>Index</b>	<b>Page</b>
Alpine Butterfly	25
Anchor Bend	13
Ashley's Stopper	35
Bachmann Knot	38
Blake's Hitch	39
Bowline 1010 (Overhand/Underhand)	18
Bowline 1034½ (Overhand /Underhand)	18
Bowline EBDB (End Bound Double Bowline)	19
Bowline EBSB + Y (End Bound Single Bowline + Yosemite Finish)	19
Bowline Eskimo	22
Bowline Lee's Locked	20
Bowline on the Bight	20
Bowline Spanish	21
Buntline Hitch	14
Carrick Bend	29
Clove Hitch (tied in the Bight)	11
Clove Hitch (tied with the Working End)	12
Constrictor (tied in the Bight)	32
Constrictor (tied with the Working End)	32
Crossed Lashing	42
Diagonal Lashing	42
Directional Figure Eight	24
Double Fisherman's Knot	28
Figure Eight Bend	27

Figure Eight Loop	23
Figure Eight Loop (re-Threaded)	23
Figure Eight Loop (Double)	23
Figure Eight Stopper	35
Fisherman's Bend	13
Flat Knot	31
Flemish Bend	27
Gleipnir Binder	34
Grapevine Knot	28
Half Hitch	9
Half Hitch	10
Half Knot	9
Hedden Knot	38
Highwayman's Hitch	17
Klemheist Knot	38
Linesman's Loop	25
Machard	38
Marlingspike Hitch	26
Midshipman's Hitch	15
Multiple Overhand Knot	36
Overhand Knot	9
Overhand/Underhand Loop and Knot	8
Parts of a Rope	7
Picket-Line Hitch (Slipped)	17
Poacher's Knot	26

Pole Lashing	34
Prohaska # 1 Knot	39
Prohaska # 2 Knot	39
Prusik Knot	37
Recovery Straps (Joining)	40
Reef Knot	31
Ring Loading	22
Ring Knot	28
Rolling Hitch	15
Round Turn and Two Half Hitches	13
Scaffold Knot	26
Seizing Bend	30
Shear Lashing	42
Sheet Bend	30
Sheet Bend (Double)	30
Simple Noose	26
Single Hitch	10
Slings (Joining)	40
Slipped Hitches	17
Spherical Stopper	35
Square Knot	31
Square Lashing	41
Stevedore Knot	35
Strangle Knot	33
Tautline Hitch	15

Timber Hitch	14
Trucker's Hitch	16
Tumble Hitch	17
Turns	12
Two Half Hitches	10
Waggoner's Hitch	16
Water Knot	28
Whipping (Common)	43
Zeppelin Bend	27